

Continental 
The Future in Motion

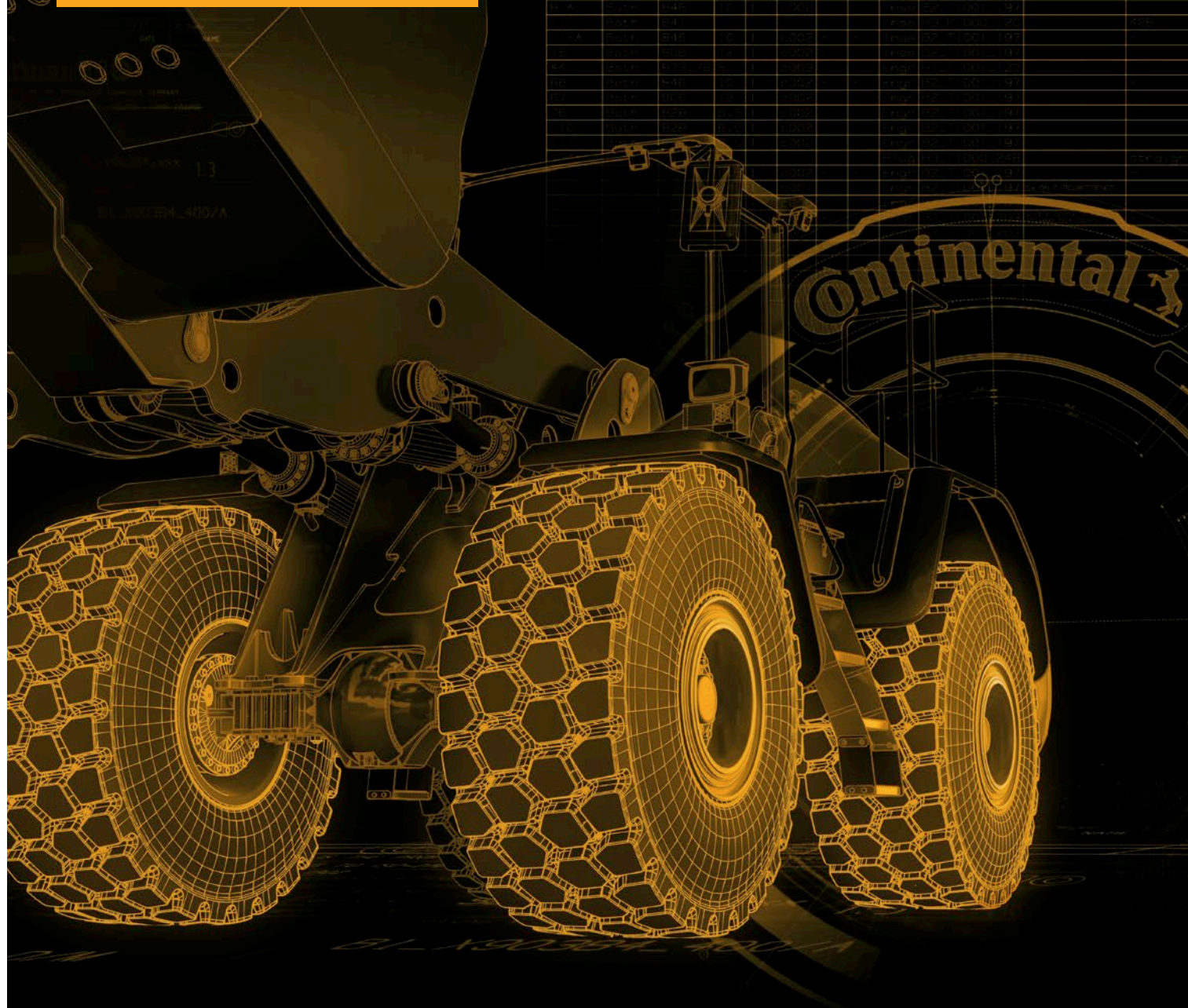

Off-The-Road Tires

Technical Data Book

Preface

This data book contains comprehensive information on our off-the-road (OTR) tire range. We recommend that the inflation pressure of every tire is checked and adjusted regularly. Wrong inflation pressure, greater loads or higher speeds than those recommended by the vehicle or tire manufacturer may shorten the service life of the tire or may result in premature failure. These instructions must be followed if tire and vehicle safety is to be guaranteed. For further information, please see our safety instructions.

Continental's OTR tires are produced in accordance with internationally accepted standards established by ETRTO (European Tyre and Rim Technical Organisation), TRA (Tire and Rim Association), JATMA (Japan Automobile Tyre Manufacturers Association) and/or ISO (International Standards Organisation). Standards comprise load capacity, inflation pressure, overall diameter, overall width, and related valves and rims, etc. In case of differences between these standards, Continental refers to the most appropriate one.

Publisher's imprint

The content of this publication is provided for information only and is subject to change. Continental Reifen Deutschland GmbH makes no representations about the accuracy, reliability, completeness or timeliness of the information in this publication. Continental Reifen Deutschland GmbH may, in its sole discretion, revise the information contained herein at any time without notice. Continental Reifen Deutschland GmbH's obligations and responsibilities regarding its products are governed solely by the agreements under which they are sold. Unless otherwise agreed in writing, the information contained herein does not become part of these agreements.

This publication does not contain any guarantee or agreed quality of Continental Reifen Deutschland GmbH's products or any warranty of merchantability, fitness for a particular purpose and non-infringement. Continental Reifen Deutschland GmbH may make changes in the products or services described at any time without notice.

This publication is provided on an "as is" basis. To the extent permitted by law, Continental Reifen Deutschland GmbH makes no warranty, express or implied and assumes no liability in connection with the use of the information contained in this publication. Continental Reifen Deutschland GmbH is not liable for any direct, indirect, incidental, consequential or punitive damages arising out of the use of this publication. Information contained herein is not intended to announce product availability anywhere in the world.

The trademarks, service marks and logos (the Trademarks) displayed in this publication are the property of Continental Reifen Deutschland GmbH and/or its affiliates. Nothing in this publication should be construed as granting any license or right to the Trademarks. Without the express written consent of Continental Reifen Deutschland GmbH the use of the Trademarks is prohibited. All text, images, graphics and other materials in this publication are subject to the copyright and other intellectual property rights of Continental Reifen Deutschland GmbH and/or its affiliates. Continental Reifen Deutschland GmbH owns the copyrights in the selection, coordination and arrangement of the materials in this publication.

These materials may not be modified or copied for commercial use or distribution.
© 2019 Continental Reifen Deutschland GmbH. All rights reserved.

OTR Tire Portfolio

Introduction	5
Application Matrix Port / Material Handling	6
Application Matrix Earthmoving	8

Classification of OTR Tires

Introduction	10
Explanation of Measurements	11
Tire Markings and Sidewall Designation	12
Aspect Ratio Designation	13
Usage Designation	14
Load Index and Speed Symbol	16
Carcass Strength	17
Dual Marked Tires	18
TKPH TMPH Rating	19

Tire Construction

Radial Construction	20
Cross-ply Construction	21
Continental V.ply Technology	22
Performance Matrix OTR Radials vs. V.ply	23
Solid Tire Construction	24

Port and Material Handling V.ply Tires

Introduction	25
Port and Material Handling V.ply Tires	26
Technical Data Port and Material Handling Tires	28
Port Radial Tires	30

Underground Mining, Surface Mining and Construction Tires

Introduction	31
Underground Mining Tires	32
Surface Mining and Construction Tires	34
Technical Data Earthmoving Tires	36

OTR Tire Maintenance and Care

Introduction	40
Tire Wear and Tread Depth Measurement	41
Pressure Maintenance	42
Regrooving	45
OTR Rims	46

Product Solutions of Continental OTR Tires

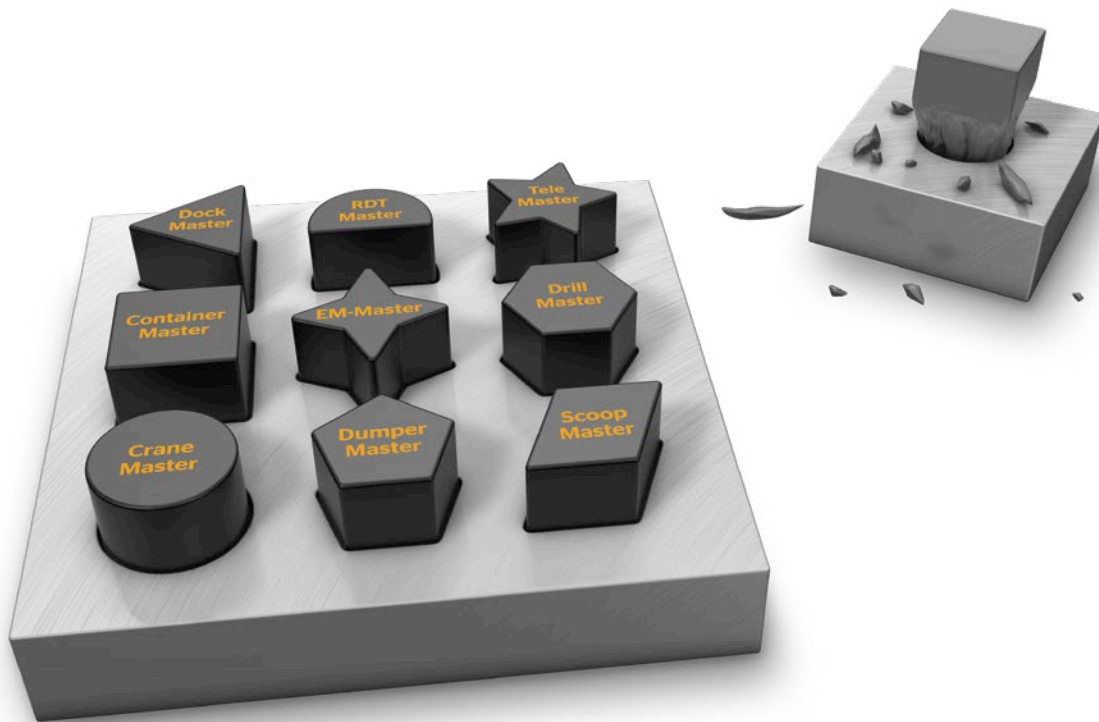

When conditions are rough and loads are high, Continental OTR tires come into their own. The letters “OTR” stand for “off the road”, and as this designation indicates, Continental OTR tires are specially designed for off-road applications, where they often have to operate on uneven, unfinished surfaces.

OTR tires are made for use on articulated or rigid dump trucks, loaders, reach stackers, various other types of specialty vehicles in ports, construction sites, and surface or underground mining. Specifically developed for harsh conditions characterized by heavy loads, sharp stones, and hard rocks, as well as wet abrasive or hard terrain, OTR tires are made to be exceptionally robust and hard-wearing.

We divide the OTR business into two groups: Material Handling and Earthmoving. In Material Handling, the primary application is large-scale heavy goods transport, i.e. container traffic in harbors and terminals, in heavy industry, and at airports. OTR tires can also be found in Earthmoving applications, where they

often have to operate under the most extreme conditions faced by wheeled vehicle.











Continental’s OTR range is made to meet the highest level of performance, safety, and durability even in the toughest environments. Extensive research and development have helped us to build customized tires of all construction types. Whether solid, radial, cross-ply or innovative V-ply tires: we offer tailored solutions from one single source that meet the demands and requirements of our customers around the world. Our premium tires offer extremely high carcass strength for an outstanding loading capacity, even on long distance transports at high speeds. They are characterized by a high resistance to damage, good traction and even wear due to innovative tread designs and durable rubber compounds.

Every tire, however, even premium products like ours, can only live up to its maximum potential and service life when properly maintained and used in accordance with standard operational practice.

This technical data book is designed to provide for both end users and manufacturers with the most important information, technical references and recommendations needed to help Continental tires reach their maximum service life. Or in other words: this book is here to help you get the best out of your tires! Whether you’re a driver, fleet manager, maintenance team or operator: if you – and everyone else in contact with our products – follow the instructions and recommendations correctly, you will be able to significantly improve performance while at the same time reducing overall operational costs and protecting the environment.

















We offer the right tires for each application and requirement.

Vehicle Matrix Port / Material Handling



		ContainerMaster+ V.ply	DockMaster+ V.ply
			
Reachstacker/ Top Loader		●	●
Empty Container Handler		●	●
Heavy Forklift		●	●
AGV			
Straddle/ Shuttle Carrier			
Rubber Tire Gantry Crane			
Airport Pushback Tractor		●	
Side Loader			

The vehicle/tire combination above refers to Continental recommendation, but in certain applications, other combinations might be possible. Please consult your Continental sales representative for your own tailor-made solution.

● Preferred application For use in other applications, please get in contact with your sales representative















TerminalMaster V.ply V.ply	CraneMaster V.ply	
		
		Reachstacker/ Top Loader 
		Empty Container Handler 
		Heavy Forklift 
		AGV 
		Straddle/ Shuttle Carrier 
		Rubber Tire Gantry Crane 
		Airport Pushback Tractor 
		Side Loader 

Vehicle Matrix Earthmoving

		EM-Master E3/L3 Radial	EM-Master E4/L4 Radial	RDT-Master Radial	DumperMaster Radial
					
Loader/Dozer		●	●		●
Articulated Dump Truck		●	●		●
Rigid Dump Truck (RDT)				●	
Grader		●	●		
Scraper		●			
Telehandler					
Underground Dump Truck			●		●
Underground Loader (Scoop)					
Support Machine					
Coal Haulers Shuttle Car					

● Preferred application

● Application possible, please contact your sales representative.

DrillMaster V.ply	UndergroundMaster V.ply	ScoopMaster V.ply	TeleMaster Solid	
				
		●		Loader/Dozer 
				Articulated Dump Truck 
				Rigid Dump Truck (RDT) 
				Grader 
				Scraper 
			●	Telehandler 
				Underground Dump Truck 
		●		Underground Loader (Scoop) 
●				Support Machine 
	●			Coal Haulers Shuttle Car 



Introduction

The off-the-road business is characterized by a huge variety of different machines ranging from reachstackers in port application to dump trucks running in the deepest underground mines. This diversity calls for specialized tires that differ in construction, tread design and compounds as well as other character-

istics. The tire industry has developed different classifications in order to make it easier to identify the right tire for the right application. The following pages give an overview of the most common classification/designation types for OTR tires.

Explanation of Tire Measurements

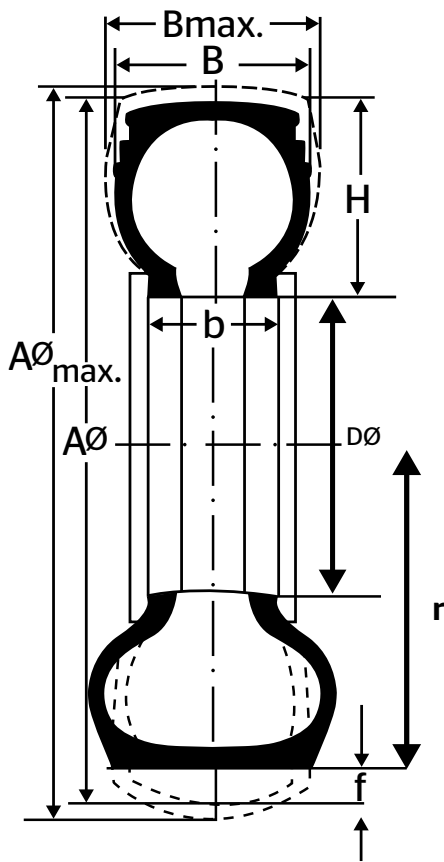

AØ	Tire outer diameter
AØ max.	Max tire outer diameter in service
B	Cross section width
Bmax.	Maximum operational width
H	Tire section height
DØ	Rim diameter
b	Rim width
r	Static loaded radius
f	Radial deflection

The dimensional data given in this data book and in the following tables complies with ETRTO standards where applicable. Additional information, such as additional tire sizes not listed in ETRTO, are provided in compliance with DIN or WdK guidelines. All data is correct at date of publication but is subject to change and cannot be guaranteed.

Note: The in-service diameter is the maximum permitted dimension as a result of growth during tire use in operation.

Tire Markings and Sidewall Designation

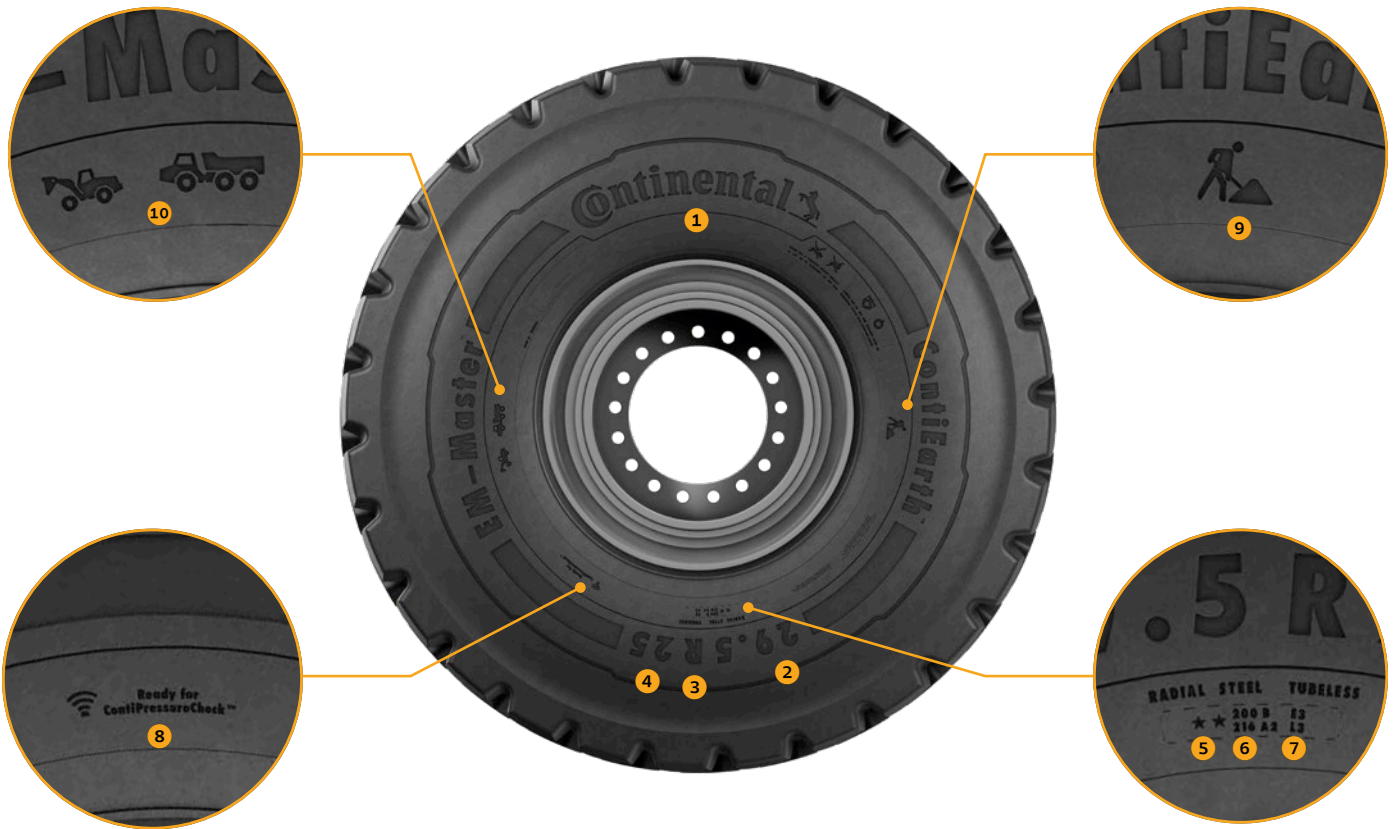

Description

1	Manufacturer	Continental
2	Nominal section width of the tire (in inches)	29.5
3	Construction	Radial Constuction
4	Rim diameter code	25
5	Star rating	★★
6	Load index and speed symbol	200B for E3 and 216A2 for L3
7	Type of application	E3 (Earthmover transport) or L3 (Loader application)
8	ContiPressureCheck ^{sensor} ((CONNECT	Ready for ContiPressureCheck
9	Type of use (pictogram)	Loader, ADT
10	Tire category (pictogram)	Construction/Earthmover

Aspect Ratio Designation

Off-the-road tires are labeled for size in one or more ways. Each size marking contains important information about the dimensions and capacity of the tire. The chart below lists the different types of size designations you may see stamped on an OTR tire sidewall along with what they mean. Please note that the table below lists the most common aspect ratio designations for OTR tires but doesn't necessarily show all designations listed in ETRTO or other technical tire and rim organizations.

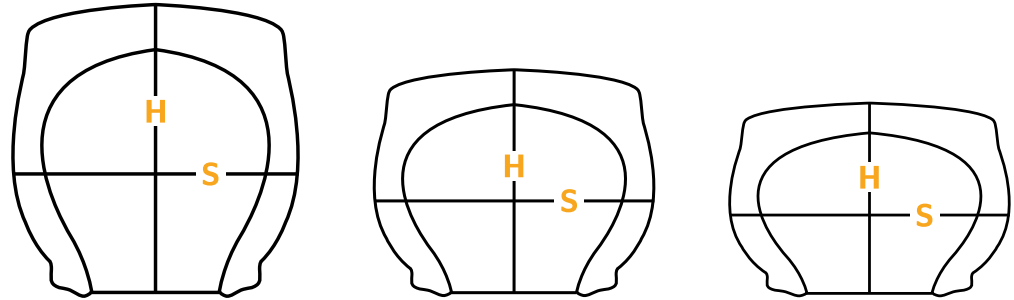

Nomenclature	Narrow Base Tires OR Conventional Tires	Wide Base Tires	Low Profile Tires OR 65 Series Tires
Aspect Ratio = H/S	≈ 0.95 to 1 (95 to 100%)	≈ 0.8 to 0.85 (80 to 85%)	≈ 0.65 (65%)
Section width is expressed in	Full inches followed by the number 00	Full inches and a fraction of inches	Full inches followed by the number 65
Example: Radial	24.00 R35	20.5 R25	35/65 R33
Example: Cross-ply	24.00-35	20.5-25	35/65-33
Approximate section width (S) based on example above	24 inch	20.5 inch	35 inch
Rim diameter code based on example above	35 inch rim diameter	25 inch rim diameter	33 inch rim diameter
Further remarks	Metric designations also available e.g. 445/95 R25 (445 mm section width and 95% aspect ratio)	Metric designations also available e.g. 525/80 R25 (525 mm section width and 80% aspect ratio)	Metric designations also available e.g. 875/65 R33 (875 mm section width and 65% aspect ratio)

70' or 75' series tires follow the same approach as for the the 65' series tires.

Usage Designation* including Tread Design & Tread Depth

Some tires have dual-markings which indicate that they were developed for a broader application range (example: E and L on the sidewall means the tire can be used both for OTR machines like ADTs but also for loaders).

The letter codes are followed by a number that represents a special kind of tread design and tread depth. In general there are five basic tread designs: Rib, Block, Traction, Rock, and Smooth. The tread depth is defined as regular tread (100%) Deep Tread (150%) or Extra Deep Tread (250%). The tread depth designation is an index which means the actual tread depth may vary depending on manufacturer and product.

Special markings on the sidewall of OTR tires help to identify the primary usage it was designed for.

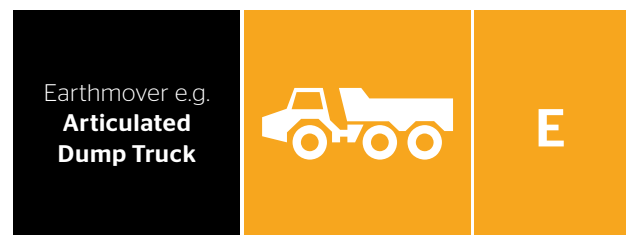

* in accordance with: ETRTO, TRA, JATMA and ISO

Usage Designation* including Tread Design & Tread Depth



The combination of the letters and numbers is often called TRA- or EM-Code and is an international classification system for OTR tires. The following table gives a rough overview of the different combinations.

TRA Classification/ EM-Code*	Tread Type (pattern design)	Application
C-1	Smooth	C = Compactor Service
C-2	Grooved	
E-1	Rib	E = Earthmover
E-2	Traction	
E-3	Rock	
E-4	Rock Deep Tread	
E-7	Flotation	
G-1	Rib	G = Grader
G-2	Traction	
G-3	Rock	
G-4	Rock Deep Tread	
H	Highway	H = Highway Service
IND-3	Industrial	IND = Industrial Service
IND-3S	Industrial Smooth	
IND-4	Industrial Deep Tread	
IND-4S	Industrial Smooth Deep Tread	
L-2	Traction	L = Loader and Dozer
L-3	Rock	
L-3S	Smooth	
L-4	Rock Deep Tread	
L-4S	Smooth Deep Tread	
L-5	Rock Extra Deep Tread	
L-5S	Smooth Extra Deep Tread	

* in accordance with: ETRTO, TRA, JATMA and ISO

Load Index and Speed Symbol

The maximum load which can be carried by a tire is indicated by the Load Index (LI). This tire LI is always related to a specific reference speed which is indicated by the Speed Symbol. In addition to the reference speed other application conditions can be specified by the tire manufacturer. It is important to understand that changing service conditions and/or different vehicle speeds may impact the load-carrying capacity of the tire.

LI	[kg]	[lbs]*	LI	[kg]	[lbs]*	LI	[kg]	[lbs]*	LI	[kg]	[lbs]*	LI	[kg]	[lbs]*	LI	[kg]	[lbs]*
1	46,2	102	43	155	342	85	515	1135	127	1750	3858	169	5800	12787	211	19500	42990
2	47,5	105	44	160	353	86	530	1168	128	1800	3968	173	6000	13228	212	20000	44092
3	48,7	107	45	165	364	87	545	1202	129	1850	4079	171	6150	13558	213	20600	45415
4	50,0	110	46	170	375	88	560	1235	130	1900	4189	172	6300	13889	214	21200	46738
5	51,5	114	47	175	386	89	580	1279	131	1950	4299	173	6500	14330	215	21800	48061
6	53,0	117	48	180	397	90	600	1323	132	2000	4410	174	6700	14771	216	22400	49383
7	54,5	120	49	185	408	91	615	1356	133	2060	4542	175	6900	15212	217	23000	50706
8	56,0	123	50	190	419	92	630	1389	134	2120	4674	176	7100	15653	218	23600	52029
9	58,0	128	51	195	430	93	650	1433	135	2180	4806	177	7300	16094	219	24300	53572
10	60,0	132	52	200	441	94	670	1477	136	2240	4938	178	7500	16535	220	25000	55116
11	61,5	136	53	206	454	95	690	1521	137	2300	5071	179	7750	17086	221	25750	56769
12	63,0	139	54	212	467	96	710	1565	138	2360	5203	180	8000	17637	222	26500	58422
13	65,0	143	55	218	481	97	730	1609	139	2430	5357	181	8250	18188	223	27250	60076
14	67,0	148	56	224	494	98	750	1653	140	2500	5512	182	8500	18739	224	28000	61729
15	69,0	152	57	230	507	99	775	1709	141	2575	5677	183	8750	19290	225	29000	63934
16	71,0	157	58	236	520	100	800	1764	142	2650	5842	184	9000	19842	226	30000	66139
17	73,0	161	59	243	536	101	825	1819	143	2725	6008	185	9250	20393	227	30750	67792
18	75,0	165	60	250	551	102	850	1874	144	2800	6173	186	9500	20944	228	31500	69446
19	77,5	171	61	257	567	103	875	1929	145	2900	6393	187	9750	21495	229	32500	71650
20	80,0	176	62	265	584	104	900	1984	146	3000	6614	188	10000	22046	230	33500	73855
21	82,5	182	63	272	600	105	925	2039	147	3075	6779	189	10300	22708	231	34500	76059
22	85,0	187	64	280	617	106	950	2094	148	3150	6945	190	10600	23369	232	35500	78264
23	87,5	193	65	290	639	107	975	2150	149	3250	7165	191	10900	24030	233	36500	80469
24	90,0	198	66	300	661	108	1000	2205	150	3350	7385	192	11200	24692	234	37500	82673
25	92,5	204	67	307	677	109	1030	2271	151	3450	7606	193	11500	25353	235	38750	85429
26	95,0	209	68	315	694	110	1060	2337	152	3550	7826	194	11800	26015	236	40000	88185
27	97,0	214	69	325	717	111	1090	2403	153	3650	8047	195	12150	26786	237	41250	90941
28	100	220	70	335	739	112	1120	2469	154	3750	8267	196	12500	27558	238	42500	93696
29	103	227	71	345	761	113	1150	2535	155	3875	8543	197	12850	28329	239	43750	96452
30	106	234	72	355	783	114	1180	2601	156	4000	8818	198	13200	29101	240	45000	99208
31	109	240	73	365	805	115	1215	2679	157	4125	9094	199	13600	29983	241	46250	101964
32	112	247	74	375	827	116	1250	2756	158	4250	9370	200	14000	30865	242	47500	104719
33	115	254	75	387	853	117	1285	2833	159	4375	9645	201	14500	31967	243	48750	107475
34	118	260	76	400	882	118	1320	2910	160	4500	9921	202	15000	33069	244	50000	110231
35	121	267	77	412	908	119	1360	2998	161	4625	10196	203	15500	34172	245	51500	113538
36	125	276	78	425	937	120	1400	3086	162	4750	10472	204	16000	35274	246	53000	116845
37	128	282	79	437	963	121	1450	3197	163	4875	10748	205	16500	36376	247	54500	120152
38	132	291	80	450	992	122	1500	3307	164	5000	11023	206	17000	37479	248	56000	123459
39	136	300	81	462	1019	123	1550	3417	165	5150	11354	207	17500	38581	249	58000	127868
40	140	309	82	475	1047	124	1600	3527	166	5300	11684	208	18000	39683	250	60000	132277
41	145	320	83	487	1074	125	1650	3638	167	5450	12015	209	18500	40785	251	61500	135584
42	150	331	84	500	1102	126	1700	3748	168	5600	12346	210	19000	41888	252	63000	138891

Speed Symbol	A 1	A 2	A 3	A 4	A 5	A 6	A 7	A 8	B	C	D	E	F	G	J	K
Speed (km/h)	5	10	15	20	25	30	35	40	50	60	65	70	80	90	100	110
Speed (mph)	3	6	9	12	16	19	22	25	31	37	40	43	50	56	62	68

Speed Symbol	L	M	N	P	Q	R	S	T	U	H	V	VR	W	ZR	Y
Speed (km/h)	120	130	140	150	160	170	180	190	200	210	240	>210	270	>240	300
Speed (mph)	75	81	87	93	99	106	112	118	124	130	149	>130	168	>149	186

* lbs and mph as rounded values

Carcass Strength: Star Rating & Ply Rating

The load-carrying capacity of a pneumatic tire is determined by air volume and inflation pressure. The compressed air in a tire is held by the carcass. In general a stronger carcass design means the tire can hold more compressed air, resulting in a higher load carrying capacity. Despite its strength, the carcass should be flexible enough to absorb shocks, which is an essential criterion for many OTR applications.

The carcass of cross-ply (bias) tires consists of rubber-coated fabric layers, also called plies, so the strength of a Cross-ply carcass is rated in PRs - Ply Ratings. The combination of tire size, ply rating and application (e.g. Loaders) is used to determine the maximum inflation pressure of the tire (NB: suitability of rim should always be checked) which results in the tire load capacity. The carcass of radial OTR tires consists of a single steel layer. The strength of the radial carcass and therefore the load capacity is indicated by the star marking.

The table shows the conversion between Star Rating and Ply Rating for some common OTR tire sizes.

Application	Dimension	Star Rating	Ply Rating
Loader	17.5R25	* **	up to 16 up to 20
	20.5R25	* **	up to 24 up to 28
	23.5R25	* **	up to 24 up to 32
	26.5R25	* **	up to 24 up to 36
	29.5R25	* **	up to 28 up to 34
	29.5R29	* **	up to 34 up to 40
	35/65R33	* **	up to 36 up to 48
Earthmover	20.5R25	* **	up to 24 up to 28
	23.5R25	* **	up to 24 up to 32
	26.5R25	**	up to 36
	29.5R25	**	up to 34
	29.5R29	**	up to 40
	33.25R35	**	up to 44
	37.25R35	**	up to 48
	18.00R33	**	up to 40
	21.00R33	**	up to 36
	24.00R35	**	up to 48

Dual Marked Tires

Some tires have been developed for a broader application range, which might mean, for instance, that the tire can be used on a Loader (Loader and Dozer operation - indicated by the TRA code L on the sidewall) as well as an Articulated Dump Truck (Earth-mover or transport operation indicated by the TRA code E on the sidewall). These tires are often called 'dual marked tires' or 'tires with dual specification codes'.

The illustration below shows how Continental marks these kinds of OTR tires.

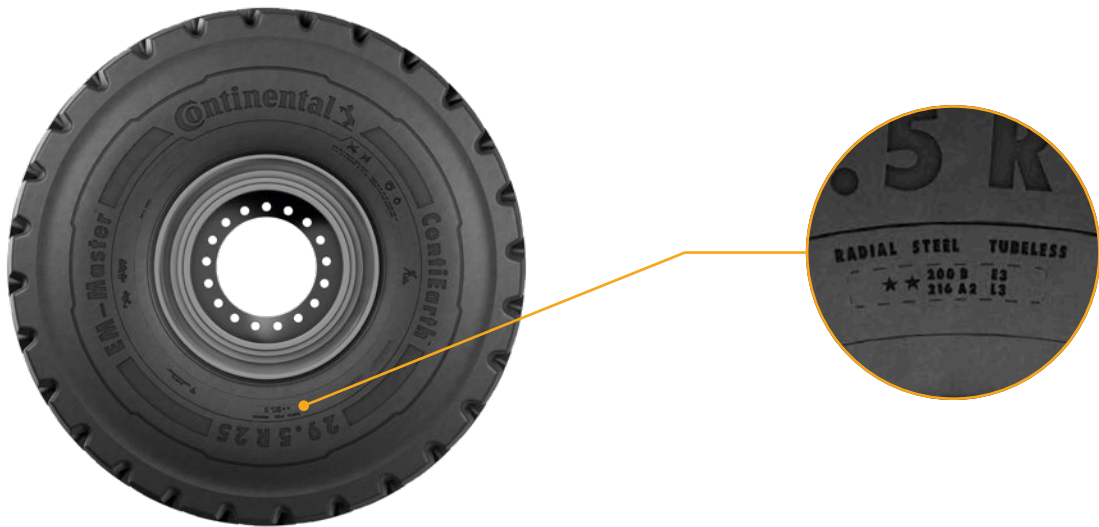

The example above shows a dual marked Continental 29.5R25 EM-Master E3/L3. Below the size designation you find the TRA-Code E3 with the corresponding Load Index 200 (14000kg; 30900 lbs) and Speed Symbol B (50 km/h; 31mph) as well as the TRA-Code L3 with the corresponding Load Index 216 (22400kg; 49400 lbs) and the Speed Symbol A2 (10 km/h; 6 mph). In this specific example the dual marked tire has for both operations (Loader and Earthmover). But there are also dual marked tires that have different star ratings for Loader and Earthmover operation (known as 'Multiple Star Ratings'). The recommended inflation pressure per tire size depends on the tire manufacturer and may vary between tire brands. In view of this, please always check the recommended technical data provided by the tire manufacturer. The table below gives an example for dual marked tires with different star ratings.

Size (example)	TRA-Code	Service Type	Star Rating	Load (Load Index)	Speed (Speed Symbol)	Inflation Pressure
Single star rating with dual marked tires						
29.5R25 EM-Master E3/L3	E3	Earthmover	** (two star)	14000kg 30900lbs (200)	50km/h 31mph (B)	5.25 bar 76 psi
	L3	Loader		22400kg 49400lbs (214)	10km/h 6mph (A2)	6.50 bar 94 psi
Multiple star rating with dual marked tires						
23.5R25 EM-Master E3/L3	E3	Earthmover	** (two star)	9250kg 20390lbs (185)	50km/h 31mph (B)	5.25 bar 76 psi
	L3	Loader	* (one star)	12150kg 26790lbs (195)	10km/h 6mph (A2)	5.00 bar 73 psi

TKPH / TMPH Rating

The abbreviation TKPH / TMPH stands for ton-kilometer-per-hour / ton-miles-per-hour and is used to describe the working capacity of OTR tires (mostly Earthmover). Every tire generates heat whenever it is on a moving wheel (e.g. due to flexion/flexing). When the heat dissipation of the tire is lower than internal heat generation, the temperature inside the tire increases steadily and can reach levels potentially harmful to the rubber and other tire components, which may reduce tire life or even result in premature tire failure. Therefore it is important to assure that the TKPH / TMPH rating of the tire is higher than the one required for the application. The TKPH / TMPH rating of Continental Earthmover tires is listed in the data book as well as on the technical data sheets. To help calculate site TKPH / TMPH, Continental has created an online version. For access, please get in touch with your Continental representative.

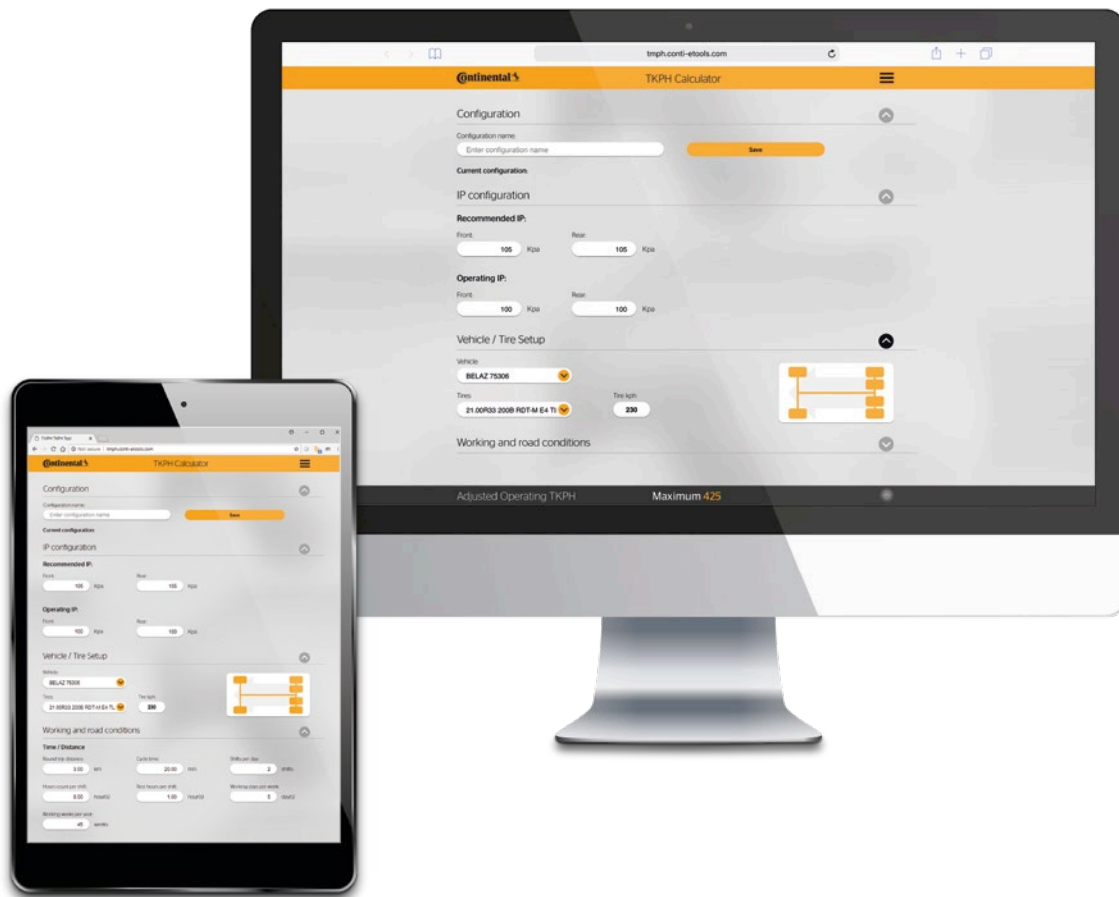

Radial Construction

There are many differences in the construction of cross-ply and radial tires. Each construction has advantages in certain applications. In order to select the appropriate tire for a specific application, an understanding of the two construction types is required.

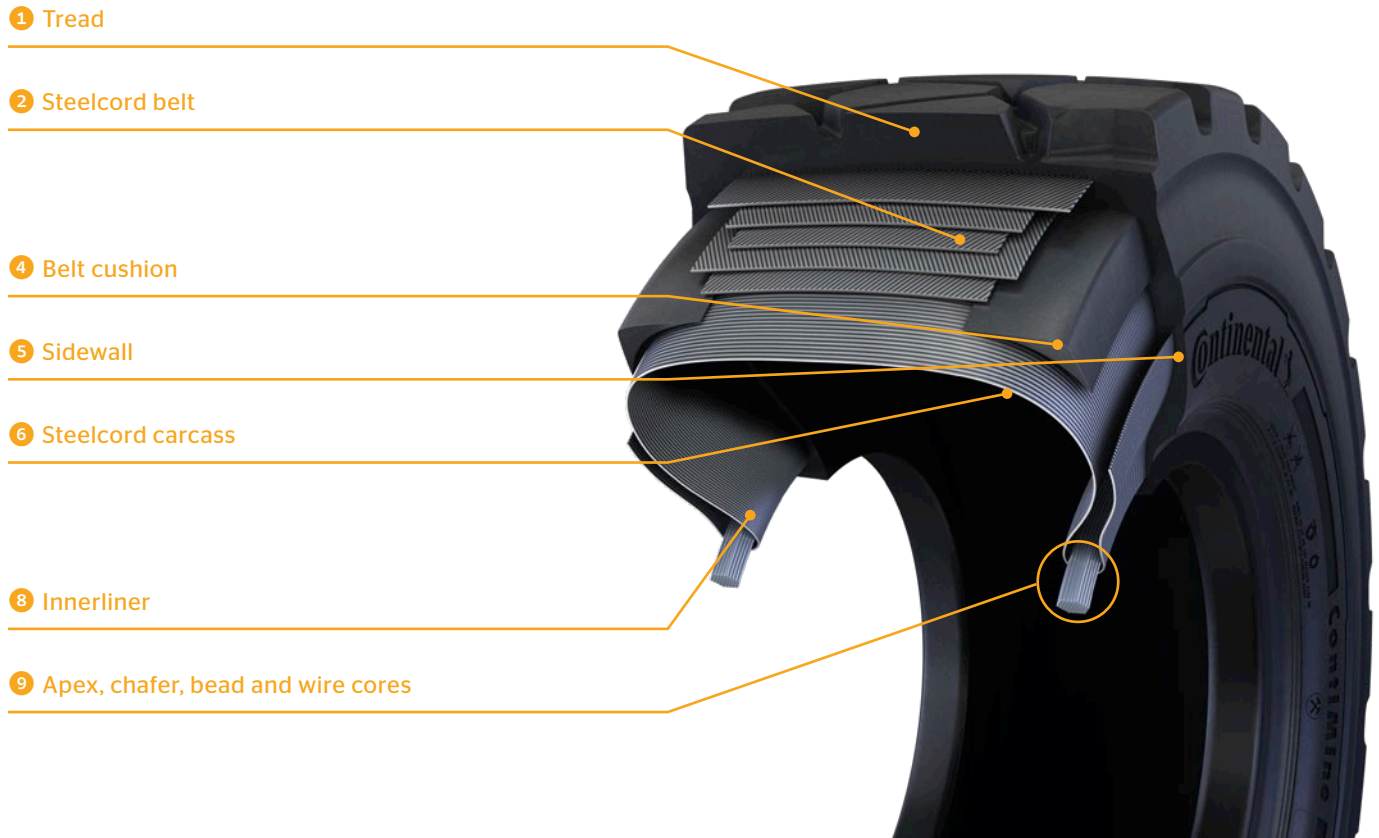

1 Tread	This wear-resistant rubber protects carcass and belt against fractures and impacts.
2 Steelcord belt	The belts are layers of steel cord located between the tread and the body ply. The belts increase the rigidity of the tread, increasing the tire's resistance to cuts.. They also transmit the torque to the radial ply and restrict tire growth.
3 Breakers	Breaker are placed between carcass and tread to protect the carcass of a Cross-ply (or bias) tire.
4 Belt cushion	This component reduces temperature generation.
5 Sidewall	The sidewall is a protective rubber coating on the outer side of the tire. It is designed to resist cutting, scuffing and cracking.
6 Steelcord carcass	The carcass acts to support air pressure and absorb shocks. It consists of steel-ply and has high strength to ensure structural durability combined with high flexibility, very good damping and rolling resistance.

In a radial construction, steel carcass material runs directly from bead to bead (radial) and the tread is stabilized by steel belts; sidewall and tread function independently of each other. The shocks absorbed by the sidewall are not transferred into the tread. There is a minimized width deformation of the contact patch. A radial tire has a carcass of one or more layers of fibers or steel at approximately 90 degrees and a belt made of crosswise-layered fibers or steel.

Cross-ply construction

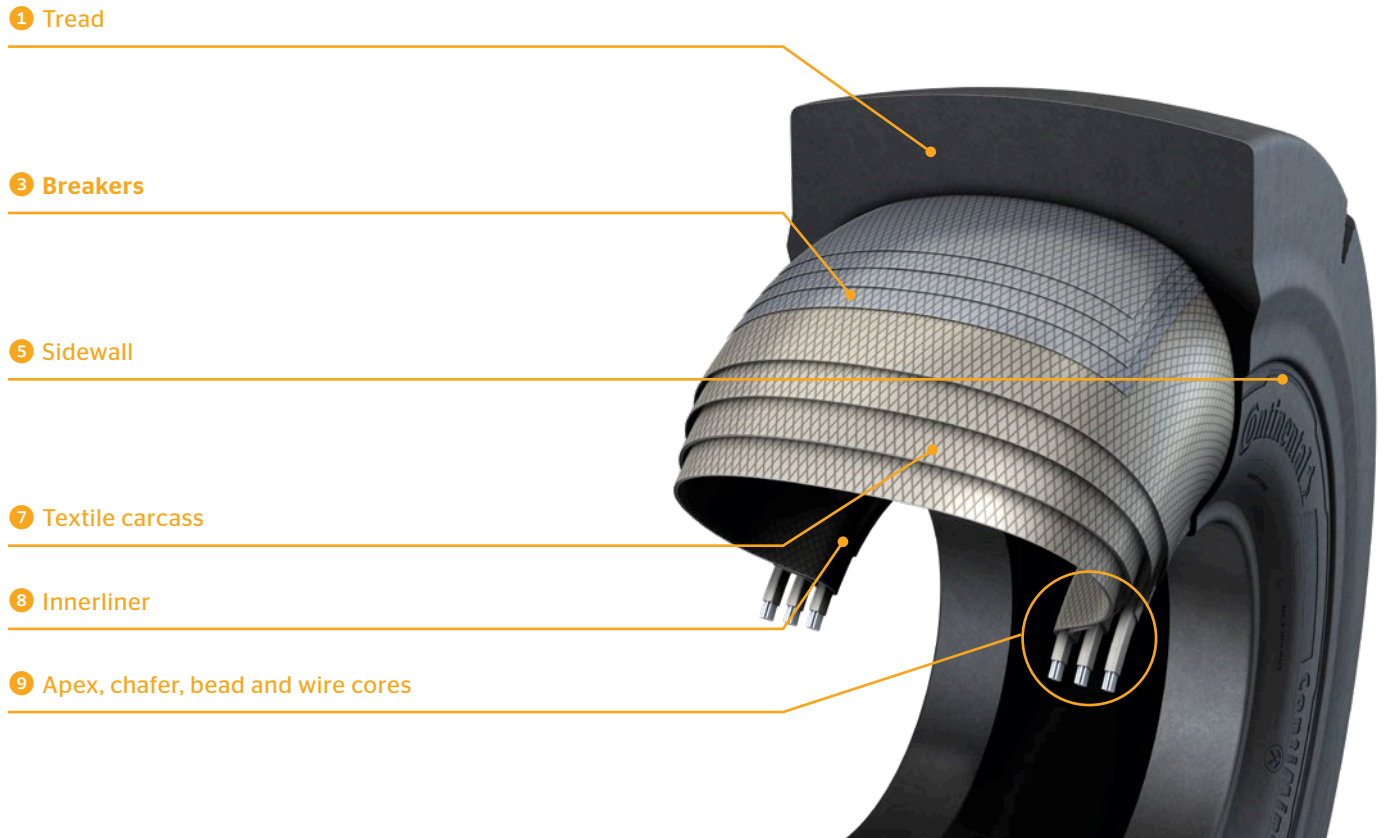

7 Textile carcass	The carcass acts to support air pressure and absorb shocks. It consists of layers of nylon plies and has high strength to ensure structural durability combined with high flexibility.
8 Innerliner	The liner is an integral part of all tubeless pneumatic tires. It covers the inside of the tire from bead to bead and ensures the airtightness of the tire.
9 Apex	Due to its hardness, the apex stabilizes the bead area.
Chafer	The chafer protects bead and body from chafing (wear from rubbing), where the tire is in contact with the rim. It offers high resistance against mechanical stress (mounting process).
Bead	Considered the foundation of the tire, it “anchors” the bead on the rim.
Wire cores	Wire cores have high strength to ensure structural durability to keep tire on the rim. The end of the cord plies are wrapped around them.

In a cross-ply construction, the carcass consists of multiple layers of fabric, running diagonally from one bead to the other. Tread and sidewall are coupled to form a single unit. All shock-absorbing movements of the sidewall are transferred into the tread, meaning that the contact patch width varies in size and shape according to the ground surface. The multiple carcass layers result in a very robust side sidewall construction.

Continental V.ply Technology

Radial

- › Enhanced mileage
- › Good riding comfort
- › Increased traction



Cross-ply

- › Good vehicle stability
- › Good self-cleaning on muddy ground
- › Damage-resistant sidewall



According to this overview, the perfect OTR tire would be a hybrid of radial and cross-ply construction offering the best of both worlds. Cross-ply provides some essential features for an OTR tire, such as good stability, good self-cleaning on muddy grounds and a high cut and damage resistance. This is due to the Cross-ply design. However, on more or less solid grounds and paved surfaces, cross-ply may display some disadvantages compared to radial tires.

Here its flexible belt leads to increased rolling resistance, less control and less traction at higher speed. Moreover, the tire flexing provides little riding comfort on asphalt roads. Therefore, cross-ply is not the best choice when it comes to applications like the surface mining (where there are often considerable distances between pit, crusher and conveying systems), and other OTR applications with longer distances and higher speeds. A truly versatile OTR tire offers high stability **and** low rolling resistance.

How can these two conflicting aims be reconciled? We at Continental have found a way to merge these core requirements into a single technology. We call it V.ply and it narrows the gap by introducing three new and innovative steps to the manufacturing process:

- › Improving the carcass ply
- › Reducing rubber
- › Optimizing the curing process

In short, V.ply is geared to significantly reduce rolling resistance while maintaining the distinctive high stability of cross-ply off-the-road tires. Nevertheless, depending on the specific application in question, a radial tire can be more suitable than a V.ply tire. Whatever the use case, we have the perfect solution.

Improved carcass

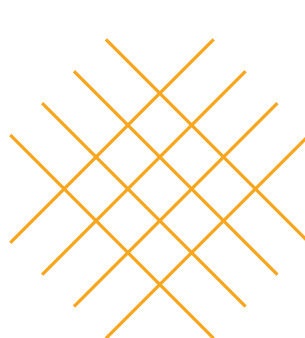

Cross-ply angle



V.ply angle

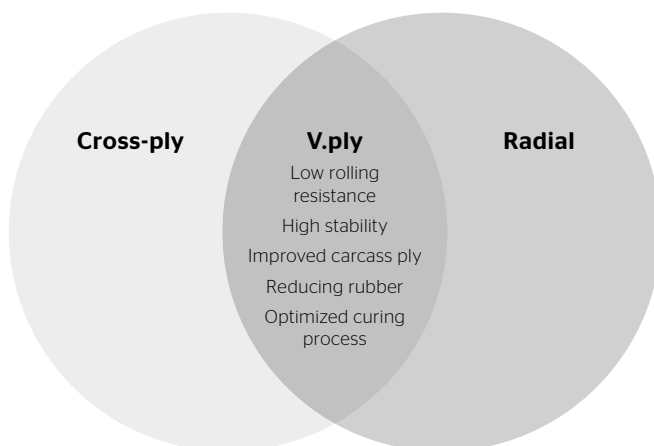

Performance Matrix OTR Radials vs. V.ply

There are advantages and disadvantages to each kind of tire construction. A brief overview and explanation of the main items is given in the table below; it is intended to help you to choose the right tire for the given vehicle application.

Criteria	Radial	V.ply	Explanation
			
Tread life	●		Less movement between tire tread and ground surface compared to V.ply tires results in less abrasion and therefore better tire life overall.
Heat generation	●		Less inner friction between the tire components of a radial tire compared to a V.ply tire (one radial steel carcass ply vs. several nylon plies) reduces transformation of kinetic energy into thermal energy.
Tread impact resistance	●		Several steel belts in the tread area of a radial tire in combination with the more flexible carcass construction offer better tread impact resistance.
Sidewall robustness		●	Due to multiple carcass layers, V.ply tires have generally thicker sidewalls compared to radial tires.
Traction	●		As a general rule, the radial construction results in higher ground contact area, allowing for better traction force transmission.
Stability		●	The thicker sidewalls of V.ply tires lower deflection in radial and axial direction, generally resulting in more stability.
Repairability		●	Thicker casing of V.ply tires tend to have better tolerance for cut / impact repairs in the tread as well as in the sidewall area.
Fuel economy	●		In general, radial tires have a lower rolling resistance than V.ply tires (primarily due to the factors listed above in 'Heat resistance').
Rim component life		●	Most V.ply tires have a wider bead than radial tires and therefore more contact area to the rim which results in less stress for the rim components as forces are distributed to a larger area.
PU-filling		●	As they don't tend to fail with the 'zipper' sidewall breaks typical of radial tires, V.ply tires tend to work better with PU fillings, a characteristic which is partly due to their multiple crossed carcass layers.

● in general better performing for that specific criteria

Solid Tire Construction (TeleMaster)

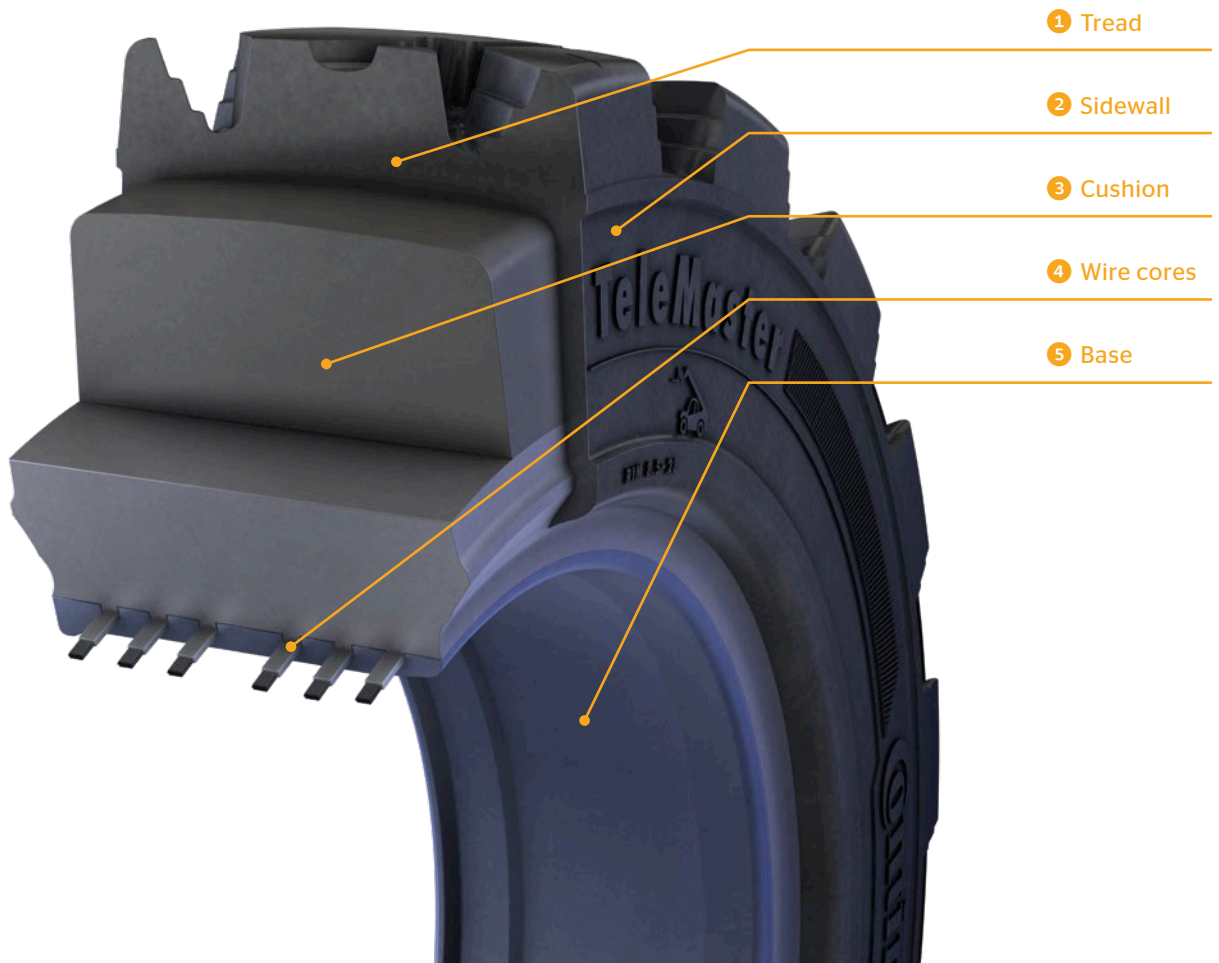

- | | | |
|---|-------------------|--|
| 1 | Tread | The tread is made of a highly cut- and wear-resistant compound, providing high tilting stability and a long service life. |
| 2 | Sidewall | The sidewall consists of a highly cut- and wear-resistant compound which protects the cushion. |
| 3 | Cushion | The cushion compounds provide for extremely low damping. This leads to low rolling resistance and, as a result, less temperature generation. |
| 4 | Wire cores | Rectangular wire cores provide even pressure distribution and excellent rim fitment. |
| 5 | Base | The base with embedded wire cores (bead strings) ensures optimal rim fitment. |



Introduction

As a leading supplier of brake systems, instrumentation, vehicle electronics and infotainment solutions, as well as systems and components for power trains and chassis, tires and technical elastomers, Continental contributes to enhanced driving safety and global climate protection.

This is why Continental has forged ahead with the production V.ply, radial, and solid tires, in order to enable us to offer products which are a perfect fit for the requirements of our customers - and not just the perfect addition to our product range.

Ports represent an exceptionally challenging environment for tires, shortening their lifespans considerably for a variety of reasons: the vehicles in use are gigantic, the cargo loads heavy, and the dockers' driving habits adventurous; moreover, port terminals have hot-spots where repeated braking, accelerating, and turning leaves cracks, ruts, and potholes. In view of this, we have developed the Continental port package.

After fuel, tires are the second largest expenditure in the maintenance of a terminal. Moreover, while most

existing ports are growing, the number of terminals worldwide continues to increase. The result is that there is big market for anyone who has got the right product. And we have. Continental's port package is a customized portfolio of speciality tires, designed to help keep vehicles in operation. So don't compromise.

OTR Material Handling V.ply



ContainerMaster+



- › Wide, flat tread area for maximum ground contact
- › Strong V.ply construction with more robust sidewalls for high load stability and less tilting
- › Enhanced tire wear compound for maximum mileage
- › All round fitment for general-use container-handling stackers



DockMaster+



- › Wide, flat tread area for maximum ground contact
- › Maximum tread volume for highest possible mileage
- › Slick pattern eliminates tread cracks in applications with high level of steering stress due to tight turns at slow speed
- › Ideal for container-handling stackers in pick and stack applications

OTR Material Handling V.ply



CraneMaster



- › Rounded tread contour for easy transfer of on the spot steering forces under high load
- › E3 tread depth for reduced steering block stress
- › Ideal for RTG applications where resistance to lateral steering stress is more important that speed and distance driving



TerminalMaster V.ply



- › Wide, flat tread area for maximum ground contact
- › Closed shoulder tread pattern for low tire and vehicle vibration
- › Three central tire ribs for directional stability
- › Ideal for AGVs and large pushback vehicles in airports

Material Handling - OTR V.ply

Size range, specifications and tire load capacities

Tire											Tire dimensions [mm]					
Size	Pattern	Code					Recommended rim	Tube	Flap	O-Ring	Continental values					
		Tread Code	Tire Type	LI	SSY	PR					Tread depth	Width ±1,0%	Outer dia. ±1,0%	Static ¹⁾ radius ±2,5%	Rolling ²⁾ Circumf.±2,5%	Min. Dual Spacing
12.00 - 24	ContainerMaster	E-4	TT	178	A5	20	8.5 / 1.7 (drop center)	S 12.00-24 F	B 220-24 REINF. AIRF	-	35.5	332	1289	599	-	-
12.00 - 24	ContainerMaster	E-4	TL	178	A5	20	8.5 / 1.7 (drop center)	-	-	OR 325T	35.5	332	1289	599	-	-
12.00 - 24	ContainerMaster+	IND-4	TT	178	A5	20	8.5 / 1.7 (drop center)	S 12.00-24 F	B 220-24 REINF. AIRF	-	35.5	332	1289	599	-	-
12.00 - 24	ContainerMaster+	IND-4	TL	178	A5	20	8.5 / 1.7 (drop center)	-	-	OR 325T	35.5	332	1289	599	-	-
14.00 - 24	ContainerMaster	E-4	TL	193	A5	28	10.00-24 WA	-	-	OR 325T	47.0	395	1405	635	-	450
14.00 - 24	ContainerMaster	E-4	TT	193	A5	28	10.00-24 WA	S 14.00-24 F	B 220-24 REINF. AIRF	-	47.0	395	1405	635	-	450
14.00 - 24	ContainerMaster+	IND-4	TL	188	A5	28	10.00-24 WA	-	-	OR 325T	47.0	395	1405	635	4089	450
14.00 - 24	ContainerMaster+	IND-4	TT	188	A5	28	10.00-24 WA	S 14.00-24 F	B 220-24 REINF. AIRF	-	47.0	395	1405	635	4089	450
14.00 - 24	CraneMaster	E-3	TT	188	A5	28	10.00-24 WA	S 14.00-24 F	B 220-24 REINF. AIRF	-	29.0	381	1356	659	4141	450
14.00 - 24	CraneMaster	E-3	TL	188	A5	28	10.00-24 WA	-	-	OR 325T	29.0	381	1356	659	4141	450
14.00 - 24	DockMaster+	IND-3S	TL	188	A5	28	10.00-24 WA	-	-	OR 325T	27.5	383	1370	-	-	450
14.00 - 24	DockMaster+	IND-3S	TT	188	A5	28	10.00-24 WA	S 14.00-24 F	B 220-24 REINF. AIRF	-	27.5	383	1370	-	-	450
16.00 - 25	ContainerMaster	E-4	TL	196	A5	32	11.25 / 2.0	-	-	OR 325T	55.5	456	1548	693	-	518
16.00 - 25	ContainerMaster+	E-4	TL	196	A5	32	11.25 / 2.0	-	-	OR 325T	55.5	456	1548	693	-	518
16.00 - 25	CraneMaster	E-3	TL	196	A5	32	11.25 / 2.0	-	-	OR 325T	35.5	450	1497	661	-	518
16.00 - 25	StraddleMaster +	E-4	TL	196	A5	32	11.25 / 2.0	-	-	OR 325T	54.0	461	1529	699	-	-
16.00 - 25	TerminalMaster V.ply	IND-4	TL	196	A5	32	11.25 / 2.0	-	-	OR 325T	54.0	461	1529	699	-	-
18.00 - 25	ContainerMaster	E-4	TL	207	A5	40	13.00 / 2.5	-	-	OR 325T	64.5	515	1694	758	5323	598
18.00 - 25	ContainerMaster+	E-4	TL	207	A5	40	13.00 / 2.5	-	-	OR 325T	64.5	515	1694	758	5077	598
18.00 - 25	ContainerMaster+ IND-3	IND-3	TL	207	A5	40	13.00 / 2.5	-	-	OR 325T	40.0	511	1622	740	4928	598
18.00 - 25	CraneMaster	E-3	TL	207	A5	40	13.00 / 2.5	-	-	OR 325T	37.5	513	1640	721	-	598
18.00 - 25	DockMaster+	E-4	TL	207	A5	40	13.00 / 2.5	-	-	OR 325T	59.0	517	1678	786	-	598
21.00 - 25	CraneMaster	E-3	TL	213	A5	40	15.00 / 3.0	-	-	OR 325T	43.0	603	1765	792	-	683
21.00 - 25	StraddleMaster	E-3	TL	213	A5	40	15.00 / 3.0	-	-	OR 325T	36.0	618	1788	798	5338	685
21.00 - 25	StraddleMaster +	IND-3	TL	213	A5	40	15.00 / 3.0	-	-	OR 325T	-	618	1788	798	5338	685
21.00 - 25	TerminalMaster V.ply	IND-3	TL	213	A5	40	15.00 / 3.0	-	-	OR 325T	36.0	618	1788	798	5338	685
18.00 - 33	ContainerMaster	E-4	TL	214	A5	40	13.00 / 2.5	-	-	OR 333T	65.0	525	1880	870	-	598
18.00 - 33	ContainerMaster+	E-4	TL	214	A5	40	13.00 / 2.5	-	-	OR 333T	65.0	525	1880	870	5670	598
21.00 - 35	CraneMaster	E-3	TL	219	A5	40	15.00 / 3.0	-	-	OR 335T	41.0	575	2013	-	-	701

1) At reference load

2) Other vehicles: platform trucks, trailers, tractive units, straddle carriers, fork lifts without counterweight, terminal tractors etc.

3) For tire used with straddle carriers and straddle fork lifts with max. speed 25 km/h and 35 km/h the load capacities of steered wheels on fork lifts have to be used

Tire load capacity [kg]										
Inflation Pressure [bar]	On other vehicles ²⁾ at max. speed [km/h]				On fork lifts max. 25 km/h ³⁾		On fork lifts max. 35 km/h ³⁾		Pattern	Size
	Stationary	10	25	35	Load wheel	Steer wheel	Load wheel	Steer wheel		
10	11300	9800	7500	6900	9800	7500	9400	6900	ContainerMaster	12.00 - 24
10	11300	9800	7500	6900	9800	7500	9400	6900	ContainerMaster	12.00 - 24
10	11300	9800	7500	6900	9800	7500	9400	6900	ContainerMaster+	12.00 - 24
10	11300	9800	7500	6900	9800	7500	9400	6900	ContainerMaster+	12.00 - 24
10	17300	15000	11500	10600	15000	11500	14400	10600	ContainerMaster	14.00 - 24
10	17300	15000	11500	10600	15000	11500	14400	10600	ContainerMaster	14.00 - 24
10	15000	13000	10000	9250	13000	10000	12500	9250	ContainerMaster+	14.00 - 24
10	15000	13000	10000	9250	13000	10000	12500	9250	ContainerMaster+	14.00 - 24
10	15000	13000	10000	9250	13000	10000	12500	9250	CraneMaster	14.00 - 24
10	15000	13000	10000	9250	13000	10000	12500	9250	CraneMaster	14.00 - 24
10	15000	13000	10000	9250	13000	10000	12500	9250	DockMaster+	14.00 - 24
10	15000	13000	10000	9250	13000	10000	12500	9250	DockMaster+	14.00 - 24
10	18800	16300	12500	11600	16300	12500	15600	11600	ContainerMaster	16.00 - 25
10	18800	16300	12500	11600	16300	12500	15600	11600	ContainerMaster+	16.00 - 25
10	18800	16300	12500	11600	16300	12500	15600	11600	CraneMaster	16.00 - 25
10	18800	16300	12500	11600	16300	12500	15600	11600	StraddleMaster +	16.00 - 25
10	18800	16300	12500	11600	16300	12500	15600	11600	TerminalMaster V.ply	16.00 - 25
10	26300	22800	17500	16200	22800	17500	21900	16200	ContainerMaster	18.00 - 25
10	26300	22800	17500	16200	22800	17500	21900	16200	ContainerMaster+	18.00 - 25
10	26300	22800	17500	16200	22800	17500	21900	16200	ContainerMaster+ IND-3	18.00 - 25
10	26300	22800	17500	16200	22800	17500	21900	16200	CraneMaster	18.00 - 25
10	26300	22800	17500	16200	22800	17500	21900	16200	DockMaster+	18.00 - 25
10	31500	27300	21000	19400	27300	21000	26300	19400	CraneMaster	21.00 - 25
10	31500	27300	21000	19400	27300	21000	26300	19400	StraddleMaster	21.00 - 25
10	31500	27300	21000	19400	27300	21000	26300	19400	StraddleMaster +	21.00 - 25
10	31500	27300	21000	19400	27300	21000	26300	19400	TerminalMaster V.ply	21.00 - 25
10	31800	27600	21200	19600	27600	21200	26500	19600	ContainerMaster	18.00 - 33
10	31800	27600	21200	19600	27600	21200	26500	19600	ContainerMaster+	18.00 - 33
10	36500	31600	24300	22500	31600	24300	30400	22500	CraneMaster	21.00 - 35



Port Radial Tires

Introduction during 2020



Introduction

Continental's new Earthmoving tire range was designed to meet the requirements of use in locations such as surface and underground mines as well as quarries or construction sites. To ensure the best fit for your application, Continental offers a range of different types of radial-, Vply- and solid tires.

Underground Mining



sensor
CONNECT

RADIAL TIRE

DumperMaster



Designed for dump trucks in harsh conditions like underground mines



Closed tread center

For carcass protection and long service life

Open shoulder design for good self cleaning abilities and traction



Sidewall protection rib

For better carcass protection against impacts and cuts

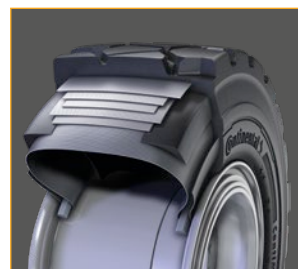

4 star carcass design

For maximum load capacity (based on inflation pressures up to 8 bar/116psi)



ScoopMaster



Designed for loaders operating in extremely harsh conditions like underground mines

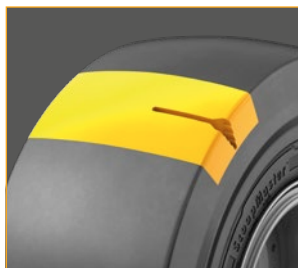

Smooth extra deep tread design

For maximum casing protection and mileage performance



Sidewall protection rib

For additional casing protection in sidewall area

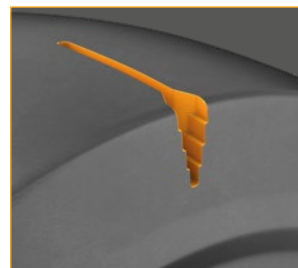

Tread wear indicator (TWI)

To reduce stone catching and resultant carcass penetration

Underground Mining



DrillMaster



Designed for machines like drill rigs operating in UG mines or tunneling applications



Tread lug design

Zigzag design with multiple edges for maximum traction in circumferential and lateral direction



Tread groove design

Round shaped tread groove to reduce stone trapping

High amount of gripping edges



V.ply construction

High load capability due to carcass construction

Low heat build-up when driving long distances



UndergroundMaster



Designed for machines like shuttle cars operating in underground soft rock mines



Tread lug design

Multiple tread edges for maximum traction in circumferential and lateral direction



Tread width

Reduced block damage due to optimized tread width, especially when cornering room-and-pillar applications



V.ply construction

High load capability due to carcass construction

Low heat build-up when driving long distances

Surface Mining / Construction



sensor
CONNECT

RADIAL TIRE

EM-Master E3/L3



Designed for loaders and articulated dump trucks



Tread blocks with multiple gripping edges

For powerful traction on soft and muddy terrain



Wide space between blocks

For outstanding self-cleaning abilities and for low heat build-up



Connection between center blocks

For improvement of traction capabilities and for smooth running



sensor
CONNECT

RADIAL TIRE

EM-Master E4/L4



Designed for loaders and articulated dump trucks



Tread blocks with multiple gripping edges

For powerful traction on gravelly and rocky terrain

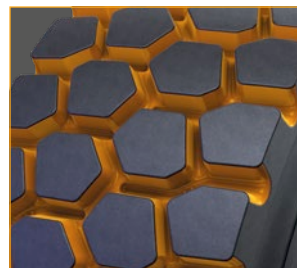

Less space between blocks than E3/L3

For more carcass protection and smoother running (less void)

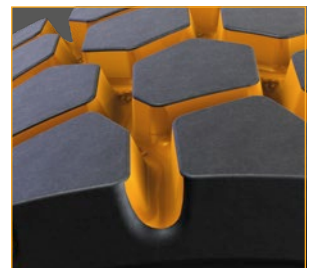

Deep tread design

For more wear volume than E3/L3 version

Surface Mining / Construction



RADIAL TIRE

RDT-Master



Designed for rigid dump trucks that transport heavy loads over longer distances

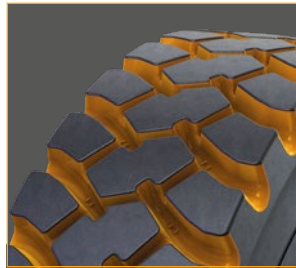

Wide tread with flat radius

For maximum traction



Open shoulder design

For good self-cleaning abilities



Deep tread

For high carcass protection against cuts and damage by foreign objects



SOLID TIRE

TeleMaster



Designed for telehandlers operating in harsh environments like building sites

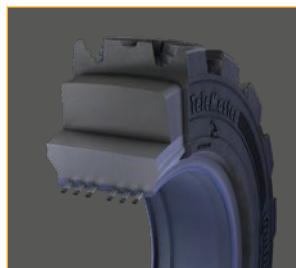

Outstanding service life and high comfort

Solid three layer construction with low rolling resistance cushion compound for longer distances and a comfortable ride



High damage protection

Cut resistance tread and sidewall compound for outstanding service life



High traction

New tread design for optimal traction in all directions

Earthmoving

Size range, specifications and tire load capacities

Tire								Continental values					Min. Dual Spacing	Recommended rim/ Flange Height
Size	Pattern	Tread Code	Tire Type	SR/PR	LI/SSY	Compound	TKPH TMPH	Tread depth mm Inch	OD mm Inch	OW mm Inch	SLR mm Inch	SLW mm Inch		
8.25 - 15	DrillMaster	L-4	TT	024	162 A2 (-)	-	-	25.0 31/32	844 33.2	239 9.4	407 16.0	-	-	6.50-15 / 1.4
10.00 - 15	DrillMaster	L-4	TT	024	167 A2 (-)	-	-	25.0 31/32	907 35.7	275 10.8	-	-	-	7.50-15 / 1.6
32 X 15 - 15	UndergroundMaster	L-3	TL	028	163 A2 (-)	-	-	24.0 30/32	829 32.6	306 12.0	-	-	-	11.50
35 X 15 - 15	UndergroundMaster	-	TL	032	167 A2 (-)	-	-	24.0 30/32	896 35.3	337 13.3	-	-	-	10.50
38 X 16 - 15	UndergroundMaster	L-3	TL	032	179 A2 (-)	-	-	24.0 30/32	976 38.4	350 13.8	-	-	-	11.50
9.00 - 20	DrillMaster	L-4	TT	020	169 A2 (-)	-	-	25.0 31/32	996 39.2	258 10.2	-	-	-	7.00-20 / 1.5
12.00 - 20	DrillMaster	L-4	TL	028	185 A2 (-)	-	-	27.0 34/32	1124 44.3	318 12.5	536 21.1	-	-	8.50-20 / 1.8
	ScoopMaster	L-5S	TT	020	173 A2 (-)	-	-	60.0 76/32	1130 44.5	309 12.2	-	-	-	8.50V-20 / 1.3
14.00 - 20	UndergroundMaster	L-3	TL	032	185 A2 (-)	-	-	29.0 37/32	1220 48.0	377 14.8	563 22.2	-	-	10.00
44 X 18 - 20	UndergroundMaster	L-3	TL	036	182 A2 (-)	-	-	28.0 35/32	1141 44.9	443 17.4	-	-	-	15.00T
12.00 - 24	DrillMaster	L-4	TL	028	187 A2 (-)	-	-	29.0 37/32	1232 48.5	322 12.7	-	-	-	8.50-24 / 1.3
	ScoopMaster	L-5S	TT	020	175 A2 (-)	-	-	57.0 72/32	1269 50.0	321 12.6	615 24.2	-	-	8.50V-24 / 1.3
14.00 - 24	DrillMaster	L-4	TT	030	195 A2 (-)	-	-	31.0 39/32	1343 52.9	386 15.2	608 23.9	-	-	10.00-24 / 1.5
	ScoopMaster	L-5S	TT	020	182 A2 (-)	-	-	72.0 91/32	1351 53.2	373 14.7	-	-	-	10.00W-24 / 1.5
16.00 - 25	DrillMaster	L-4	TL	034	203 A2 (-)	-	-	35.0 44/32	1489 58.6	436 17.2	710 28.0	-	-	11.25-25 / 2.0
17.5 - 25	ScoopMaster	L-5S	TL	020	182 A2 (-)	-	-	69.0 87/32	1362 53.6	446 17.6	612 24.1	-	-	14.00-25 / 1.5
18.00 - 25	ScoopMaster	L-5S	TL	032	202 A2 (-)	-	-	88.0 111/32	1632 64.3	509 20.0	-	-	-	13.00-25 / 2.5
		L-5S		032	202 A2 (-)									
20.5 R 25	EM-Master E3/L3	E-3	TL	**	177 B (186A2)	-	149 102.1	37.0 47/32	1485 58.5	512 20.2	657 25.9	580 22.8	-	17.00 x 25 / 2.0
		L-3		*	186 A2 (186A2)									
		E-3		**	177 B (186A2)									
		L-3		*	186 A2 (186A2)									
20.5 - 25	ScoopMaster	L-5S	TL	024	190 A2 (-)	-	-	79.0 100/32	1504 59.2	513 20.2	-	-	-	17.00-25 / 2.0
23.5 R 25	EM-Master E3/L3	E-3	TL	**	185 B (195A2)	-	142 97.3	39.0 49/32	1615 63.6	605 23.8	711 28.0	687 27.0	-	19.50 x 25 / 2.5
		L-3		*	195 A2 (195A2)									
		E-3		**	185 B (195A2)									
		L-3		*	195 A2 (195A2)									
23.5 - 25	EM-Master E4/L4	E-4	TL	**	185 B (195A2)	-	122 83.6	49.0 62/32	1609 63.3	603 23.7	710 28.0	678 26.7	-	19.50 x 25 / 2.5
		L-4		*	195 A2 (195A2)									
23.5 - 25	ScoopMaster	L-5S	TL	032	201 A2 (-)	-	-	88.0 111/32	1631 64.2	593 23.3	-	-	-	19.50-25 / 2.5

SLR (static loaded radius) and SLW (static loaded width) at reference load

Tire load capacity applicable for cyclic service only.

For further load/speed combinations please contact your local Continental sales representative.

Please always assure that rims/wheels are appropriate for the intended service (inflation pressure, speed, load).

The content of this data table is subject to change without further notice.

Tire Load Capacity at Different Cold Inflation Pressures																Max. Speed	Application	Pattern	Size
bar	4,00	4,25	4,50	4,75	5,00	5,25	5,50	5,75	6,00	6,25	6,50	7,00	7,50	8,00	8,50	km/h			
psi	58	62	65	69	73	76	80	83	87	91	94	102	109	116	123	mph			
kg lbs	2775 6118	2875 6338	2975 6559	3075 6779	3175 7000	3250 7165	3350 7385	3450 7606	3525 7771	3600 7937	3700 8157	3850 8488	4025 8874	4175 9204	4325 9535	10 6	Loader	DrillMaster	8.25 - 15
kg lbs	3200 7055	3300 7275	3425 7551	3525 7771	3625 7992	3750 8267	3850 8488	3950 8708	4050 8929	4150 9149	4250 9370	4425 9755	4600 10141	4775 10527	4950 10913	10 6	Loader	DrillMaster	10.00 - 15
kg lbs	2850 6283	2950 6504	3050 6724	3150 6945	3250 7165	3350 7385	3450 7606	3525 7771	3625 7992	3700 8157	3800 8378	3950 8708	4125 9094	4275 9425	4425 9755	10 6	Loader	UndergroundMaster	32 X 15 - 15
kg lbs	3200 7055	3300 7275	3425 7551	3525 7771	3625 7992	3750 8267	3850 8488	3950 8708	4050 8929	4150 9149	4250 9370	4425 9755	4600 10141	4775 10527	4950 10913	10 6	Loader	UndergroundMaster	35 X 15 - 15
kg lbs	4525 9976	4700 10362	4850 10692	5000 11023	5150 11354	5300 11684	5450 12015	5600 12346	5750 12677	5900 13007	6050 13338	6300 13889	6550 14440	6800 14991	7050 15543	10 6	Loader	UndergroundMaster	38 X 16 - 15
kg lbs	3400 7496	3525 7771	3650 8047	3750 8267	3875 8543	3975 8763	4100 9039	4200 9259	4300 9480	4400 9700	4500 9921	4700 10362	4900 10803	5100 11244	5300 11684	10 6	Loader	DrillMaster	9.00 - 20
kg lbs	5400 11905	5600 12346	5800 12787	6000 13228	6150 13558	6350 13999	6550 14440	6700 14771	6850 15102	7050 15543	7200 15873	7500 16535	7800 17196	8100 17857	8400 18519	10 6	Loader	DrillMaster	12.00 - 20
kg lbs	4050 8929	4200 9259	4350 9590	4475 9866	4625 10196	4750 10472	4875 10748	5000 11023	5150 11354	5250 11574	5400 11905	5600 12346	5850 12897	6100 13448	6300 13889	10 6	Loader	ScoopMaster	
kg lbs	5400 11905	5600 12346	5800 12787	6000 13228	6150 13558	6350 13999	6550 14440	6700 14771	6850 15102	7050 15543	7200 15873	7500 16535	7800 17196	8100 17857	8400 18519	10 6	Loader	UndergroundMaster	14.00 - 20
kg lbs	4975 10968	5150 11354	5350 11795	5500 12125	5650 12456	5850 12897	6000 13228	6150 13558	6300 13889	6450 14220	6600 14550	6900 15212	7200 15873	7450 16424	7750 17086	10 6	Loader	UndergroundMaster	44 X 18 - 20
kg lbs	5700 12566	5900 13007	6100 13448	6300 13889	6500 14330	6700 14771	6900 15212	7050 15543	7250 15983	7400 16314	7600 16755	7900 17416	8250 18188	8550 18850	8850 19511	10 6	Loader	DrillMaster	12.00 - 24
kg lbs	4525 9976	4675 10307	4850 10692	5000 11023	5150 11354	5300 11684	5450 12015	5600 12346	5750 12677	5850 12897	6000 13228	6250 13779	6550 14440	6800 14991	-	10 6	Loader	ScoopMaster	
kg lbs	7100 15653	7350 16204	7600 16755	7850 17306	8100 17857	8350 18409	8550 18850	8800 19401	9000 19842	9250 20393	9450 20834	9850 21716	10300 22708	10700 23589	11100 24471	10 6	Loader	DrillMaster	14.00 - 24
kg lbs	6150 13558	6350 13999	6550 14440	6800 14991	7000 15432	7200 15873	7400 16314	7600 16755	7750 17086	7950 17527	8150 17968	8500 18739	-	-	-	10 6	Loader	ScoopMaster	
kg lbs	9050 19952	9400 20723	9700 21385	10000 22046	10300 22708	10600 23369	10900 24030	11200 24692	11500 25353	11800 26015	12100 26676	12600 27778	13100 28881	13600 29983	14100 31085	10 6	Loader	DrillMaster	16.00 - 25
kg lbs	6700 14771	6950 15322	7200 15873	7400 16314	7650 16865	7850 17306	8100 17857	8300 18298	8500 18739	-	-	-	-	-	-	10 6	Loader	ScoopMaster	17.5 - 25
kg lbs	10400 22928	10800 23810	11100 24471	11500 25353	11800 26015	12200 26896	12500 27558	13200 28219	13200 29101	13500 29762	13800 30424	14400 31747	15000 33069	-	-	10 6	Loader	ScoopMaster	18.00 - 25
kg lbs	10400 22928	10800 23810	11100 24471	11500 25353	11800 26015	12200 26896	12500 27558	12800 28219	13200 29101	13500 29762	13800 30424	14400 31747	15000 33069	-	-	10 6	Loader		
kg lbs	5800 12800	6150 13600	6500 14300	6700 14800	6900 15200	7300 16100	-	-	-	-	-	-	-	-	-	50 31	Earthmoving	EM-Master E3/L3	20.5 R 25
kg lbs	8000 17600	8250 18200	8750 19300	9000 19800	9500 20900	-	-	-	-	-	-	-	-	-	-	10 6	Loader		
kg lbs	5800 12800	6150 13600	6500 14300	6700 14800	6900 15200	7300 16100	-	-	-	-	-	-	-	-	-	50 31	Earthmoving		
kg lbs	8000 17600	8250 18200	8750 19300	9000 19800	9500 20900	-	-	-	-	-	-	-	-	-	-	10 6	Loader		
kg lbs	8800 19401	9100 20062	9400 20723	9700 21385	10000 22046	10300 22708	-	-	-	-	-	-	-	-	-	10 6	Loader	ScoopMaster	20.5 - 25
kg lbs	7500 16500	7750 17100	8250 18200	8500 18700	9000 19800	9250 20400	-	-	-	-	-	-	-	-	-	50 31	Earthmoving	EM-Master E3/L3	23.5 R 25
kg lbs	10300 22700	10600 23400	11200 24700	11500 25400	12150 26800	-	-	-	-	-	-	-	-	-	-	10 6	Loader		
kg lbs	7500 16500	7750 17100	8250 18200	8500 18700	9000 19800	9250 20400	-	-	-	-	-	-	-	-	-	50 31	Earthmoving		
kg lbs	10300 22700	10600 23400	11200 24700	11500 25400	12150 26800	-	-	-	-	-	-	-	-	-	-	10 6	Loader		
kg lbs	7500 16500	7750 17100	8250 18200	8500 18700	9000 19800	9250 20400	-	-	-	-	-	-	-	-	-	50 31	Earthmoving	EM-Master E4/L4	23.5 - 25
kg lbs	10300 22700	10600 23400	11200 24700	11500 25400	12150 26800	-	-	-	-	-	-	-	-	-	-	10 6	Loader		
kg lbs	10900 24030	11300 24912	11700 25794	12100 26676	12400 27337	12800 28219	13200 29101	13500 29762	13800 30424	14200 31306	14500 31967	-	-	-	-	10 6	Loader	ScoopMaster	23.5 - 25

Earthmoving

Size range, specifications and tire load capacities

Tire								Continental values					Min. Dual Spacing	Recommended rim/ Flange Height
Size	Pattern	Tread Code	Tire Type	SR/PR	LI/SSY	Compound	TKPH TMPH	Tread depth mm Inch	OD mm Inch	OW mm Inch	SLR mm Inch	SLW mm Inch		
26.5 R 25	DumperMaster	E-4	TL	****	210 A8 (-)	-	180 123.3	57.0 72/32	1769 69.6	690 27.2	792 31.2	764 30.1	-	22.00 x 25 / 3.0
		E-4		****	-- (-)									
		E-4		****	-- (-)									
	EM-Master E3/L3	E-3	TL	**	193 B (209A2)	-	220 150.7	41.0 52/32	1736 68.3	691 27.2	781 30.7	761 30.0	-	22.00 x 25 / 3.0
		L-3		**	209 A2 (209A2)									
		E-3		**	193 B (209A2)									
		L-3		**	209 A2 (209A2)									
	EM-Master E4/L4	E-4	TL	**	193 B (209A2)	-	180 123.3	52.0 66/32	1739 68.5	697 27.4	788 31.0	764 30.1	-	22.00 x 25 / 3.0
		L-4		**	209 A2 (209A2)									
	26.5 - 25	ScoopMaster	L-5S	TL	036	209 A2 (-)	-	-	95.0 120/32	1789 70.4	706 27.8	-	-	-
L-5S			036		209 A2 (-)									
29.5 R 25	DumperMaster	E-4	TL	****	217 A8 (-)	-	220 150.7	59.0 74/32	1870 73.6	774 30.5	835 32.9	867 34.1	-	25.00 x 25 / 3.5
		E-4		****	-- (-)									
		E-4		****	-- (-)									
	EM-Master E3/L3	E-3	TL	**	200 B (216A2)	-	200 137	46.0 58/32	1843 72.6	759 29.9	815 32.1	856 33.7	-	25.00 x 25 / 3.5
		L-3		**	216 A2 (216A2)									
		E-3		**	200 B (216A2)									
		L-3		**	216 A2 (216A2)									
	EM-Master E4/L4	E-4	TL	**	200 B (216A2)	-	225 154.1	59.0 74/32	1852 72.9	780 30.7	835 32.9	859 33.8	-	25.00 x 25 / 3.5
		L-4		**	216 A2 (216A2)									
	29.5 - 25	ScoopMaster	L-5S	TL	040	216 A2 (-)	-	-	100.0 126/32	1905 75.0	751 29.6	-	-	-
29.5 - 29	ScoopMaster	L-5S	TL	040	218 A2 (-)	-	-	112.0 141/32	1983 78.1	749 29.5	-	-	-	25.00-29 / 3.5
18.00 R 33	RDT-Master	E-4	TL	**	191 B (-)	-	230 157.5	54.0 68/32	1873 73.7	518 20.4	865 34.1	578 22.8	598 23.5	33x13.00 / 2.5
	RDT-Master CR	E-4	TL	**	191 B (-)	-	184 126	54.0 68/32	1873 73.7	518 20.4	865 34.1	578 22.8	598 23.5	33x13.00 / 2.5
21.00 R 33	RDT-Master	E-4	TL	**	200 B (-)	-	252 172.6	58.0 73/32	2000 78.7	603 23.7	915 36.0	680 26.8	685 27.0	15.00 x 33 / 3.0
	RDT-Master CR	E-4	TL	**	200 B (-)	-	202 138.4	58.0 73/32	2000 78.7	603 23.7	915 36.0	680 26.8	685 27.0	15.00 x 33 / 3.0
35/65 R 33	DumperMaster	E-4	TL	****	225 A8 (-)	-	250 171.2	60.0 76/32	2056 80.9	877 34.5	913 35.9	966 38.0	-	28.00x33 / 3.5
		E-4		****	-- (-)									
		E-4		****	-- (-)									
24.00 R 35	RDT-Master	E-4	TL	**	209 B (-)	-	378 258.9	70.0 88/32	2180 85.8	670 26.4	989 38.9	772 30.4	784 30.9	17.00 x 35 / 3.5

SLR (static loaded radius) and SLW (static loaded width) at reference load

Tire load capacity applicable for cyclic service only.

For further load/speed combinations please contact your local Continental sales representative.

Please always assure that rims/wheels are appropriate for the intended service (inflation pressure, speed, load).

The content of this data table is subject to change without further notice.

Tire Load Capacity at Different Cold Inflation Pressures																Max. Speed	Application	Pattern	Size
bar	4,00	4,25	4,50	4,75	5,00	5,25	5,50	5,75	6,00	6,25	6,50	7,00	7,50	8,00	8,50	km/h			
psi	58	62	65	69	73	76	80	83	87	91	94	102	109	116	123	mph			
kg lbs	9500 21000	9750 21500	10300 22800	10600 23400	11200 24700	11500 25400	-	-	-	-	-	-	-	-	-	50 31	Earthmoving	DumperMaster	26.5 R 25
kg lbs	12850 28300	13200 29100	14000 30900	14500 32000	15000 33100	15500 34200	16000 35300	16500 36400	17000 37500	18000 39700	18500 40800	-	-	-	-	10 6	Loader		
kg lbs	-	-	-	-	-	-	14500 32000	15000 33100	15500 34200	16000 35300	16500 36400	17000 37500	18000 39700	19000 41900	-	40 25	Underground		
kg lbs	9500 20900	9750 21500	10300 22700	10600 23400	11200 24700	11500 25400	-	-	-	-	-	-	-	-	-	50 31	Earthmoving	EM-Master E3/L3	
kg lbs	12850 28300	13200 29100	14000 30900	14500 32000	15000 33100	15500 34200	16000 35300	16500 36400	17000 37500	18000 39700	18500 40800	-	-	-	-	10 6	Loader		
kg lbs	9500 20900	9750 21500	10300 22700	10600 23400	11200 24700	11500 25400	-	-	-	-	-	-	-	-	-	50 31	Earthmoving		
kg lbs	12850 28300	13200 29100	14000 30900	14500 32000	15000 33100	15500 34200	16000 35300	16500 36400	17000 37500	18000 39700	18500 40800	-	-	-	-	10 6	Loader	EM-Master E4/L4	
kg lbs	9500 21000	9750 21500	10300 22800	10600 23400	11200 24700	11500 25400	-	-	-	-	-	-	-	-	-	50 31	Earthmoving		
kg lbs	12850 28300	13200 29100	14000 30900	14500 32000	15000 33100	15500 34200	16000 35300	16500 36400	17000 37500	18000 39700	18500 40800	-	-	-	-	10 6	Loader	ScoopMaster	26.5 - 25
kg lbs	13500 29762	13900 30644	14400 31747	14900 32849	15300 33731	15800 34833	16200 35715	16600 36597	17100 37699	17500 38581	17900 39463	-	-	-	-	10 6	Loader		
kg lbs	13500 29762	13900 30644	14400 31747	14900 32849	15300 33731	15800 34833	16200 35715	16600 36597	17100 37699	17500 38581	17900 39463	-	-	-	-	10 6	Loader	DumperMaster	29.5 R 25
kg lbs	11500 25400	11800 26100	12500 27600	12850 28400	13600 30000	14000 30900	-	-	-	-	-	-	-	-	-	50 31	Earthmoving		
kg lbs	15500 34200	16000 35300	17000 37500	17500 38600	18000 39700	19000 41900	19500 43000	20000 44100	20600 45500	21200 46800	22400 49400	-	-	-	-	10 6	Loader		
kg lbs	-	-	-	-	-	-	17500 38600	18000 39700	18500 40800	19000 41900	19500 43000	20600 45400	21800 48100	23000 50700	-	40 25	Underground		
kg lbs	11500 25400	11800 26000	12500 27600	12850 28300	13600 30000	14000 20900	-	-	-	-	-	-	-	-	-	50 31	Earthmoving		
kg lbs	15500 34200	16000 35300	17000 37500	17500 38600	18000 39700	19000 41900	19500 43000	20000 44100	20600 45400	21200 46700	22400 49400	-	-	-	-	10 6	Loader		
kg lbs	11500 25400	11800 26000	12500 27600	12850 28300	13600 30000	14000 30900	-	-	-	-	-	-	-	-	-	50 31	Earthmoving	EM-Master E4/L4	
kg lbs	15500 34200	16000 35300	17000 37500	17500 38600	18000 39700	19000 41900	19500 43000	20000 44100	20600 45400	21200 46700	22400 49400	-	-	-	-	10 6	Loader		
kg lbs	17300 38140	17900 39463	18500 40785	19100 42108	19700 43431	20200 44533	20800 45856	21300 46958	21900 48281	22400 49383	-	-	-	-	-	10 6	Loader	ScoopMaster	29.5 - 25
kg lbs	18200 40124	18800 41447	19500 42990	20100 44313	20700 45636	21300 46958	21900 48281	22500 49604	23000 50706	23600 52029	-	-	-	-	-	10 6	Loader	ScoopMaster	29.5 - 29
kg lbs	-	-	-	7750 17100	8000 17600	8500 18700	8750 19300	9000 19800	9250 20400	9750 21500	10000 22000	10300 22700	10900 24000	-	-	50 31	Earthmoving	RDT-Master	18.00 R 33
kg lbs	-	-	-	7750 17100	8000 17600	8500 18700	8750 19300	9000 19800	9250 20400	9750 21500	10000 22000	10300 22700	10900 24000	-	-	50 31	Earthmoving	RDT-Master CR	
kg lbs	-	-	-	10000 22000	10300 22700	10900 24000	11200 24700	11500 25400	11800 26000	12500 27600	12850 28300	13200 29100	14000 30900	-	-	50 31	Earthmoving	RDT-Master	21.00 R 33
kg lbs	-	-	-	10000 22000	10300 22700	10900 24000	11200 24700	11500 25400	11800 26000	12500 27600	12850 28300	13200 29100	14000 30900	-	-	50 31	Earthmoving	RDT-Master CR	
kg lbs	14000 30900	15000 33100	15500 34200	16000 35300	17000 37500	17500 38600	-	-	-	-	-	-	-	-	-	50 31	Earthmoving	DumperMaster	35/65 R 33
kg lbs	19500 43000	20600 45500	21200 46800	22400 49400	23000 50800	23600 52100	25000 55200	25750 56800	26500 58500	27250 60100	28000 61800	-	-	-	-	10 6	Loader		
kg lbs	-	-	-	-	20000 44100	21200 46800	21800 48100	22400 49400	23000 50800	23600 52100	24300 53600	25750 56800	27250 60100	29000 64000	-	40 25	Underground		
kg lbs	-	-	-	13200 29100	13600 30000	14000 30900	14500 32000	15500 34200	16000 35300	16500 36400	17000 37500	17500 38600	18500 40800	-	-	50 31	Earthmoving	RDT-Master	24.00 R 35



Introduction

Regular tire and rim inspection is necessary to detect any unusual wear or damage that may occur in service as early as possible.

Before commencing any vehicle inspection, please ensure the vehicle is in a stationary and secure position. Please also ensure that visible notification is displayed in and around the vehicle indicating that a tire inspection is being undertaken.

Any punctures, cuts, penetrations, visible signs of distortion in the tread and

sidewall should be fully examined by a tire professional before the tire is put back into service. It is also important to examine the rim for any signs of damage or leakage and ensure the bolting torque is in line with the vehicle manufacturer's instructions. After every inspection, make sure a valve cap is fitted and in good condition and replace if necessary.

If any of the following defects are found, the tire in question must be removed from service: bead damage, cords showing through in the tread or sidewall, signs of separation,

damage from corrosive substances, indication of flat-running, underinflation and/or overload (e.g. inner liner abrasion, mid- to upper sidewall abrasion and stamping deterioration, delamination, or discoloration, excessive tread shoulder wear, etc).

Please note that the mentioned defects are just examples and are not supposed to give a complete overview.

Before removing a complete wheel (tire & rim) or demounting a tire always ensure that the assembly is fully deflated.

Tire wear & tread depth measurement

Tire wear measurement should only be carried out with a proper tire tread depth gauge. The tread depth should be measured on several points across the tread area and around the circumference. When measuring tread, depth always check for signs of tire wear and any signs of abnormal wear or condition. Abnormal wear may be indicative of vehicle maintenance issues and should be investigated by a tire professional to establish the cause. A tire should be replaced if the legal or technical tread depth limit has been reached or exceeded.



Tire repair

Any repairs should only be carried out by a full qualified expert with experience and knowledge of OTR tires.

Before any repair is attempted, a full investigation of the tire must be made to establish its suitability for repair and whether it can be used again after repair. In case of punctures and the tire being run in an underinflated condition, a full investigation of the tire interior must be made to establish suitability beforehand.

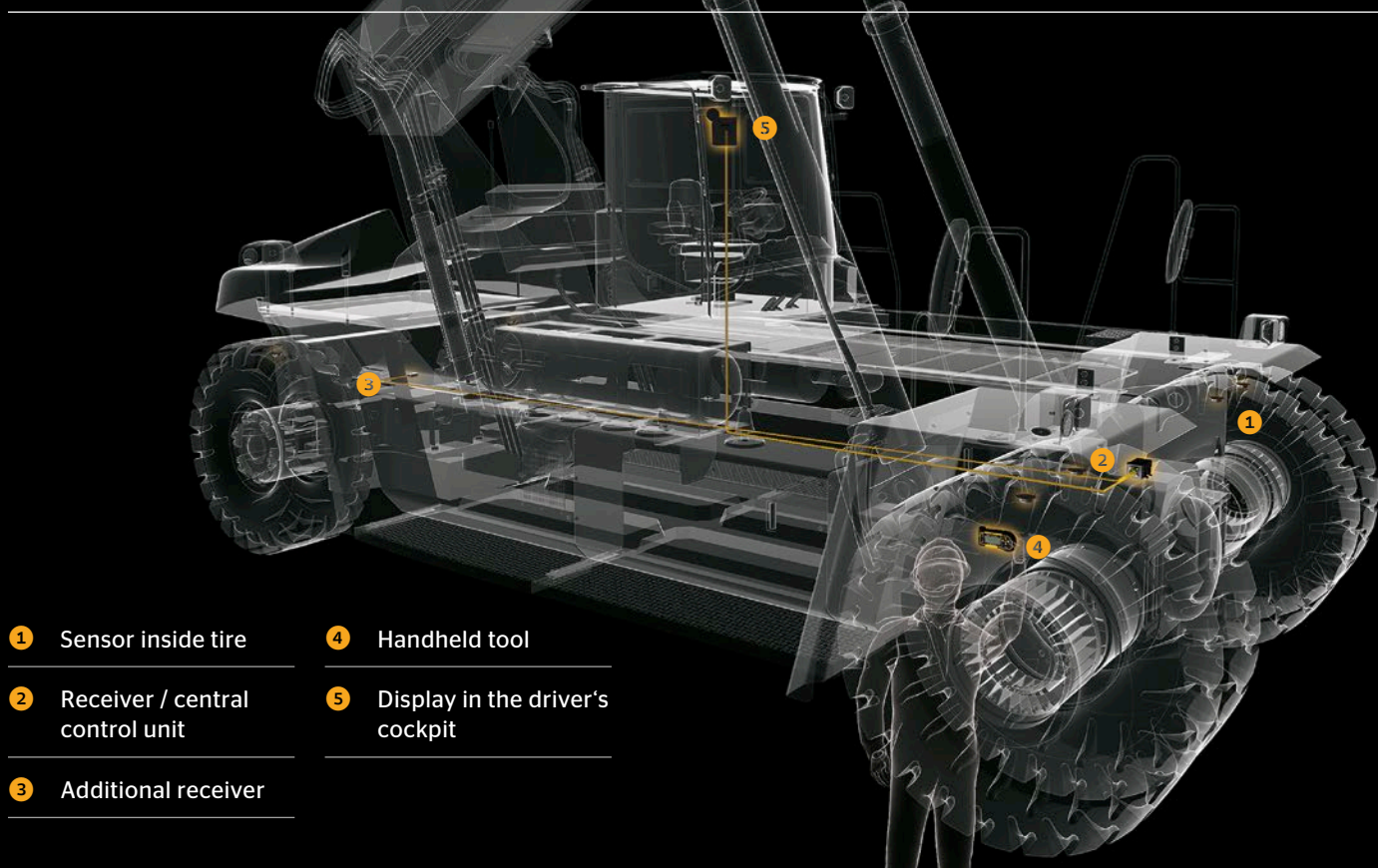

- 1** Sensor inside tire

2 Receiver / central control unit

3 Additional receiver
- 4** Handheld tool

5 Display in the driver's cockpit

Pressure maintenance

As tires lose pressure naturally, it is important that tire pressure is checked regularly, manually or via an automatic tire pressure monitoring system such as ContiPressureCheck or ContiConnect to ensure the correct air pressure is maintained. A tire operating below the recommended air pressure will experience an increase in operating temperature which can damage the construction of the tire and which, in turn, could lead to premature tire failure. An underinflated tire will also increase wear and fuel consumption, while correct tire pressure will ensure a long life of the casing and thus increases its chances of being suitable for retreading. When checking tire pressures, it is essential to comply with the vehicle manufacturer's recommendations; the maximum tire pressure defined by the tire manufacturer should not be exceeded. Please note the recommended working condition may vary due to environmental conditions such as air ambient temperature, the application in question and the vehicle the tire is fitted on.

Effects on a tire when operating at incorrect inflation.

- › **Based on a 18.00-33 dimension a reduction of service life of 8 % would be the result when running the tire at 10 % below recommended tire pressure.**
- › **Costs of under inflation = tire price x 8 %**
- › **Only 92 % of the designated life is used.**
- › **This results in higher expenses for tires, not including the fitment and service costs.**

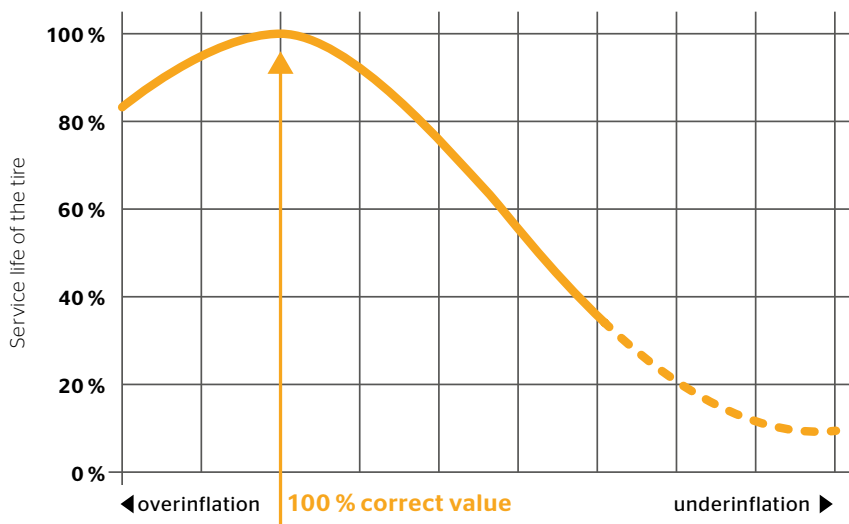

ContiPressureCheck / ContiConnect Digital monitoring systems



Using a sensor mounted in the tire, the ContiPressureCheck system automatically and continuously measures the pressure and temperature of all tires on the vehicle in real-time. A dashboard display provides the driver with a real time status even while driving, removing the need for independent manual air pressure checks, reducing workload and increasing safety.

Display in the driver's cockpit

The display shows the status of the tires and indicates seven different types of warnings and the related tire position in the driver's cabin.

ContiConnect is an extension of the ContiPressureCheck system. It's a digital tire monitoring platform for fleets with multiple vehicles in select markets worldwide. Sensors mounted inside the tires transmit tire pressure and temperature data to a yard reader station and report the status to a web portal. ContiConnect provides fleet operations with an overview of the fleet status and customized notifications regarding tire-pressure issues in real time; this allows timely action to be taken in order to avoid costly breakdowns. Both systems remove the need for independent manual air pressure checks, increasing uptime and lowering maintenance costs as well as maximizing fuel savings. Safety is also increased by eliminating the need for an operator to manually check pressures.

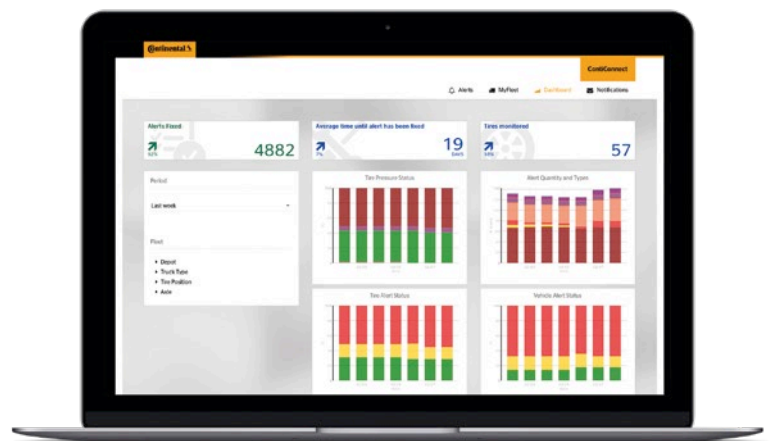

ContiConnect™ web portal allows fleet managers to access low pressure alerts, track data over time or view detailed reports and analytics in a convenient one-stop interface. If low tire pressure or high temperatures are detected, operators will receive an alert allowing them to proactively fix the problem.

ContiConnect™ light is the ideal entry level solution for drivers. It displays tire pressure and temperature using a hand-held tool, while allowing manual data upload later on to the ContiConnect™ web portal.

ContiConnect™ Yard receives all tire data whenever trucks return to the yard. The yard reader station wirelessly picks up the sensor data and transmits it to the ContiConnect™ web portal via cellular network.

ContiConnect™ Live provides real time online integration with the web portal and is compatible with multiple telematics providers/devices.



Tire pressure maintenance

Correct tire inflation pressure is essential not only to ensure optimum tire performance, but for safety inasmuch as correct pressure keeps vehicle behavior such as braking, road holding and stability constant. In addition to safety, operators will see benefits in terms of increased fuel economy, reduced wear and tear, and lower risks of premature tire failure caused by heat-induced tire deterioration due to over-flexing of the sidewall.

The recommend air pressures are based on the tires being cold, with cold being defined as the temperature of the tire after it has been stationary for a period of approximately three hours (25" tire; figures may vary for other diameters). To get an accurate pressure reading, it is therefore essential that the tires be in this condition when air pressure is checked.

As tires lose pressure in service naturally, tire pressure should be checked regularly in order to ensure that it matches the recommended pressure as recommended by the vehicle and/or tire manufacturer.

Should the tire need to be inflated, the following safety guidelines are to be followed:

- › Operators must wear all legally required personal safety equipment, e.g. hardhat, safety glasses, safety shoes, gloves, fluorescent safety vest.

- › Operators must also be trained in the correct procedures to measure tire pressure and tire inflation - and apply correct procedure at all times.

- › Operators must ensure that the vehicle is stationary and properly secured, e.g. engine switched off, brakes on, blocks engaged on the wheels to ensure the vehicle cannot roll.

During inflation, the operator should use an inflation hose and must stand at least six meters away from the tire; specifically, the operator should not stand in parallel to the sidewall in order to ensure they will not be in the blast path should the tire burst. All equipment used should be in good working order.

For further information on tire pressure maintenance and for information on Continental's automatic tire pressure monitoring systems, please contact your local Continental representative.



Regrooving of tires

After the tread pattern has been worn down, tires are regrooved by removing rubber from the remaining tread in to make new grooves; this new tread pattern extends the service life of the tire.

Regrooving should only be carried out on tires marked “regroovable” on the tire sidewall. Furthermore, tires should only be regrooved by qualified persons and any regrooving must comply with regulations valid for the country in which the tire is in use.

Tires should not be regrooved if the tire in the remaining tread area shows a high level of damage (e.g. multiple cuts or missing tire chunks) and the carcass material (belts) is showing.

When regrooving, it is important to ensure that the correct equipment is used and that operators wear all personal safety equipment legally required, e.g. hardhat, safety glasses, safety shoes, gloves, fluorescent safety vest.

For further information on regrooving, please contact your local Continental representative.

Rim types for Continental OTR tires

Tires can only function properly when mounted on the correct rim. There are three main types of rim: single piece, three piece and five piece. All rims can, however, come in different formats: flat based, full tapered, semi drop center and drop center. Please note that rims for tubeless tires and tire with tubes may be different.

When mounting rims, it is important to check for defects such as cracks or corrosion, all of which can lead to air leakage and may reduce both traction and braking performance.

Types of rim

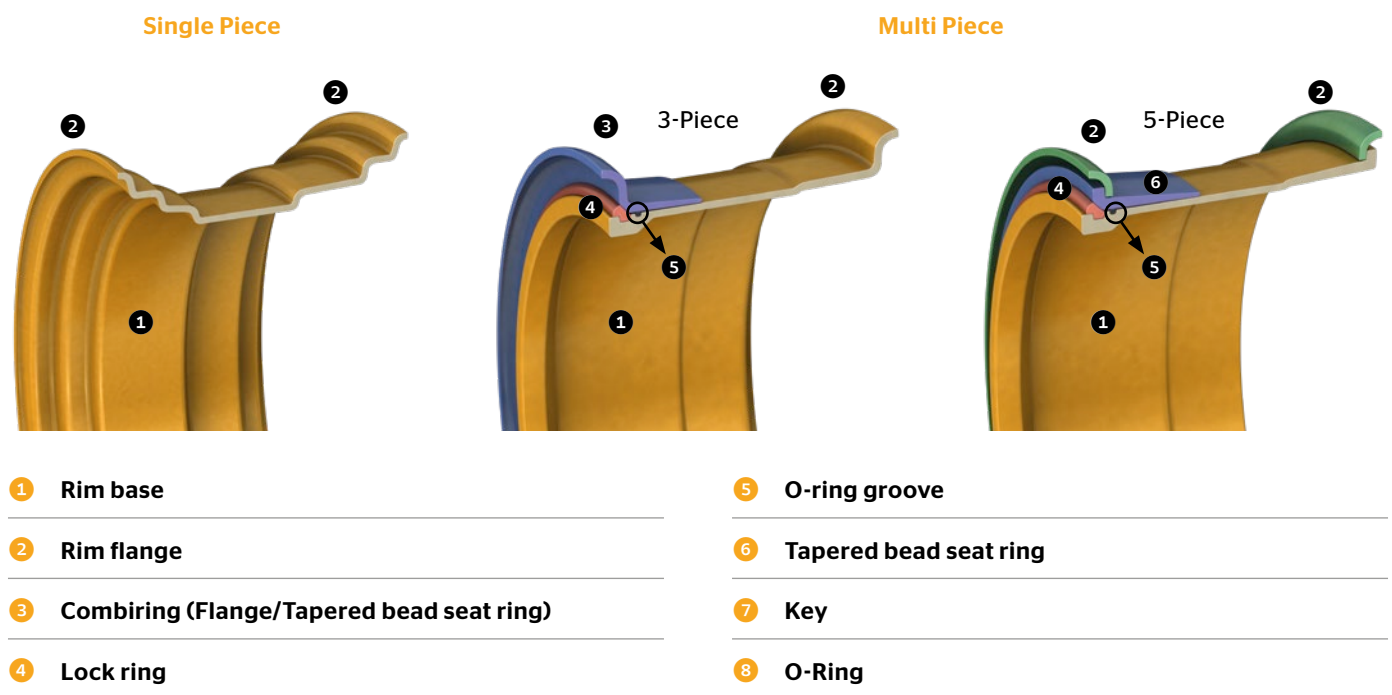

Rim types for Continental OTR tires

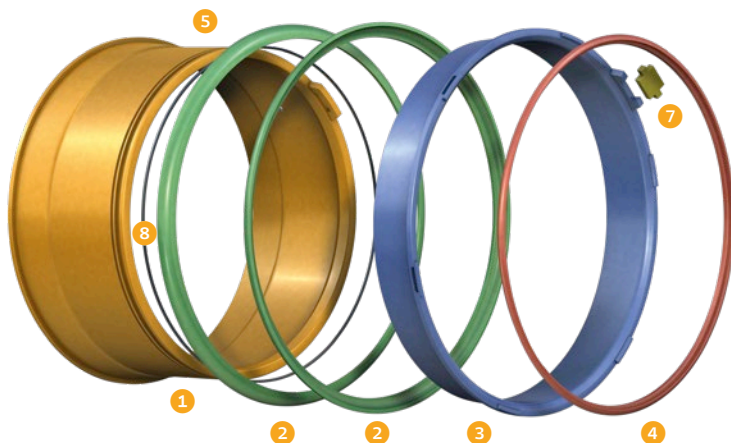

Rim identification

Full tapered bead seat rims

17.00 x 25 - 2 2 - Flange height (inch)
Or 25 - Nominal rim diameter (inch)
25 x 17.00 - 2 17.00 - Nominal rim width (inch)

Flat base rims

9.00 V x 24 24 - Rim diameter (inch)
Or V - Flange identification
24 x 9.00 V 9.00 - Rim width (inch)

When selecting rims

- › Ensure correct rim width
- › Ensure proper rim components
- › Ensure correct rim diameter and flange height
- › Check for any bent/broken/cracked rusted components and replace/clean if necessary
- › Check condition of lug nuts and replace is necessary
- › Check studs and replace if necessary
- › Check O-ring condition and replace if necessary (always replace in case of any doubts)
- › Check condition of valve and replace if necessary
- › Remove any rust, dirt and any other foreign matter from the ring surface and especially in the bead seat and O ring slot
- › Do not attempt to repair any part of the rim that is cracked or damaged.
- › **IMPORTANT: IF IN DOUBT, REPLACE**

Continental Reifen Deutschland GmbH
Commercial Specialty Tires
Büttnerstraße 25
30165 Hannover
Germany
www.continental-specialty-tires.com