

# Tyre Basics

## Passenger Car Tyres



2013 / 2014 ▶

The content of this publication is provided for information only and without responsibility. Continental Reifen Deutschland GmbH makes no representations about the accuracy, reliability, completeness or timeliness of the information in this publication. Continental Reifen Deutschland GmbH may, in its sole discretion, revise the information contained herein at any time without notice.

Continental Reifen Deutschland GmbH's obligations and responsibilities regarding its products are governed solely by the agreements under which they are sold. Unless otherwise agreed in writing, the information contained herein does not become part of these agreements. This publication does not contain any guarantee or agreed quality of Continental Reifen Deutschland GmbH's products or any warranty of merchantability, fitness for a particular purpose and non-infringement. Continental Reifen Deutschland GmbH may make changes in the products or services described at any time without notice.

This publication is provided on an "as is" basis. To the extent permitted by law, Continental Reifen Deutschland GmbH makes no warranty, express or implied, and assumes no liability in connection with the use of the information contained in this publication. Continental Reifen Deutschland GmbH is not liable for any direct, indirect, incidental, consequential or punitive damages arising out of the use of this publication. Information contained herein is not intended to announce product availability anywhere in the world.

The trademarks, service marks and logos (the Trademarks) displayed in this publication are the property of Continental Reifen Deutschland GmbH and/or its affiliates.

Nothing in this publication should be construed as granting any license or right to the Trademarks. Without the express written consent of Continental Reifen Deutschland GmbH the use of the Trademarks is prohibited.

All text, images, graphics and other materials in this publication are subject to the copyright and other intellectual property rights of Continental Reifen Deutschland GmbH and/or its affiliates. Continental Reifen Deutschland GmbH owns the copyrights in the selection, coordination and arrangement of the materials in this publication. These materials may not be modified or copied for commercial use or distribution.

Copyright © 2013 Continental Reifen Deutschland GmbH  
All rights reserved.

TDC 10/2013  
0130 1620

# Contents

Introduction . . . . . 4

## Steps in the Development of the Pneumatic Tyre:

Coming a Long Way . . . . . 5

## The Inside Story

Materials used in a tyre . . . . . 10

Tyre Components . . . . . 11

Components and Their Functions . . . . . 12

## Tyre Production

- A Glance Around the Factory . . . . . 14

## The Outside of a Tyre

Information on the Sidewall . . . . . 18

Tread Pattern . . . . . 20

## Tyre Tips

Tyre Selection/Service Description . . . . . 22

Inflation Pressure . . . . . 23

Winter Tyres . . . . . 24

Tyre Storage . . . . . 27

Wheels and Rims . . . . . 28

The EU Tyre Label . . . . . 30

## Introduction

The tyre is a complex technical component of today's motor cars and must perform a variety of functions.

It must cushion, dampen, assure good directional stability, and provide long-term service.

Most important of all, however, it must be capable of transmitting strong longitudinal and lateral forces (during braking, accelerating and cornering manoeuvres) in order to assure optimal and reliable roadholding quality. It must be able to do all of this even when the road provides little traction in wet or slippery conditions or when the road is covered with snow or ice.

A high-tech tyre must be as balanced as possible in all of its characteristics. Focussing development entirely on a single aspect is inevitable to the detriment of all other properties. For example, a tyre optimised solely with respect to rolling resistance would, by necessity, perform less well in another area. Wet braking is a classic example where a conflict of goals comes into play.



Safety enjoys high priority in tyre development at Continental. A reduction in rolling resistance must not be achieved at the expense of shorter braking distances, good handling and safe characteristics in the wet.

The solution to this conflict is to improve both properties at a high level of development.

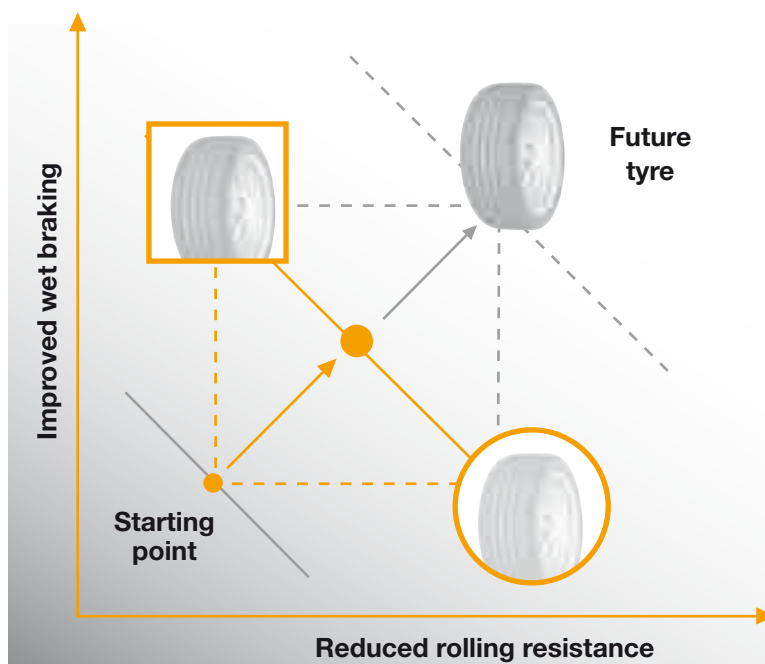

Accordingly, the current Continental winter tyres have been decisively improved in wet grip and rolling resistance.

# Steps in the Development of the Pneumatic Tyre

The wheel, as such, is not a natural phenomenon.

And yet it wasn't invented in the modern sense of the word. For more than 5,000 years, the wheel has been reinvented at different times and in different regions to meet current transportation needs.

In its earliest forms, for example, used in Mesopotamia or ancient Egypt, the wheel was made as a solid disc with three segments held together by circular pieces of metal or leather. The principle of a disc revolving on an axis was known from pottery making – the wheel is thus an early example of technology transfer. (Contrary to wide misconception, the wheel did not evolve from the use of tree trunk slabs cut horizontally because they're neither round nor durable enough for such purposes). These awkward and clumsy wooden disc wheels were later developed into spoked wheels, but only for more superior vehicles like war or ritual chariots. Spoked wheels were lighter, stronger and more stable – but they were also much more technologically sophisticated. The felloes often had large-headed nails to prolong the wheel's life.

Spoked wooden wheels lasted until the modern era of coaches, and then usually with iron tyres. Even the first Benz motor car introduced in 1886, which was basically a motorised carriage, still had spoked wooden wheels, albeit with solid rubber tyres.

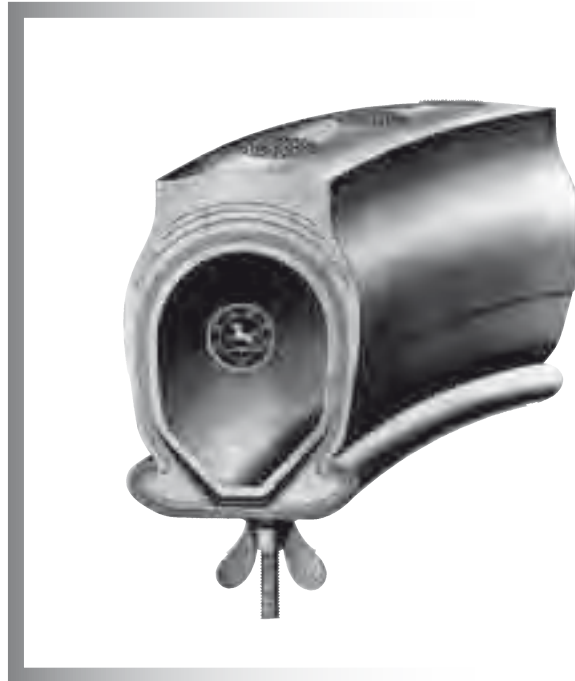

*Cross-section of a tyre around 1910*

## Steps in the Development of the Pneumatic Tyre

The **pneumatic tyre** was invented later, firstly for bicycles (Dunlop 1888) and subsequently for automobiles. In 1898 Continental started producing so called “pneumatics”, tyres capable of giving a more comfortable (cushioned) ride and enabling automobiles to travel at higher speeds.

Continental also made a significant contribution towards further technical advances of the pneumatic tyre: From 1904 onwards, tyres featured a **tread pattern** (see page 20) and were given their typical **black colour**. The addition of carbon black made tyres tougher and more durable.

Around 1920 the cord tyre came from the U.S.A. (see page 7). This tyre had a body made of cotton cord which was more resilient, less susceptible to punctures, and longer-lasting.

The **low-pressure tyre** or “balloon” (inflated at just under 3 bar instead of the previous 5 bar or more) was invented in the mid-1920s. It was followed in the 1940s by the “super balloon” tyre which had a larger volume of air and better comfort.

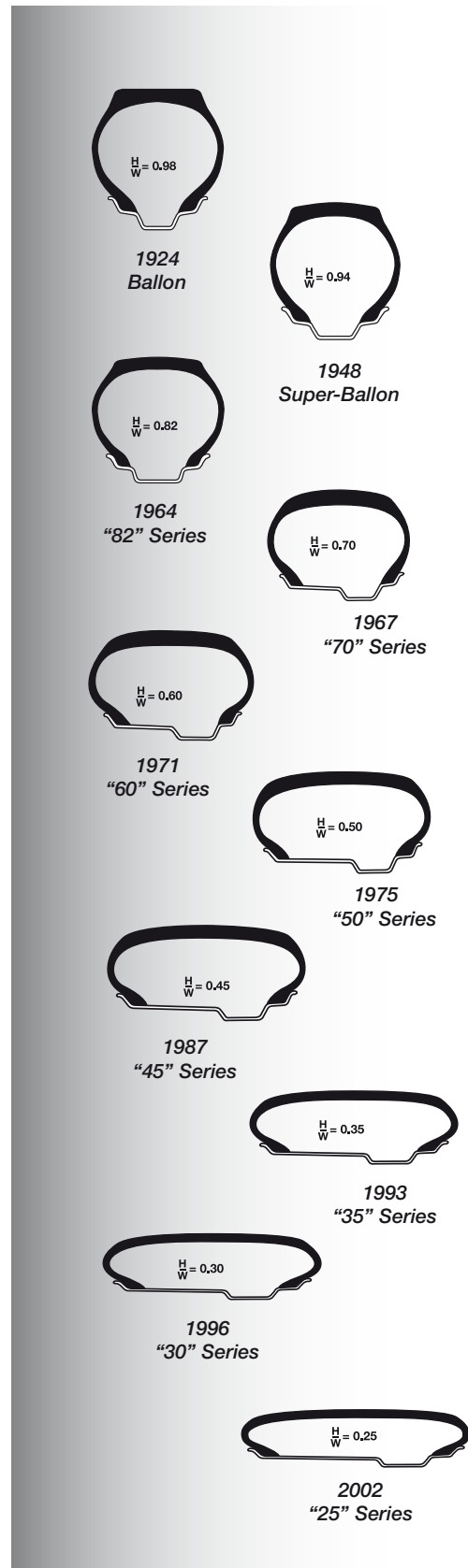

*H:W - Height / Width aspect ratio of a tyre (also called 'series')*

In the early 1950s the **steel radial tyre** (see page 8) set new standards in mileage and handling performance. By 1970 the former cross-ply tyre had disappeared from the passenger car market (this didn't apply to truck tyres however). **Low profile tyres** were invented at the same time, and 70% profile tyres were followed within just a few years by the 60% and 50% profile tyres (see illustration page 6).

A height-width ratio (aspect ratio) of 65% is standard for many vehicles today and modern tyres are getting even wider – now having a height-width ratio as low as 25%. These ultra-low-profile tyres are, however, built for special high performance cars.

The fact that tyres manufactured today by Continental are nothing less than **high-tech products** is made very clear by the following details:

Since 1975 the maximum speeds possible with Continental tyres have risen from 210 km/h to 350 km/h. At the same time the weight of an average-size tyre has actually been reduced from close to 12 to a good 8 kilograms.

Modern passenger car radials are composed of up to 25 different structural parts and as many as 12 different rubber compounds (details on page 10ff). The **main structural elements** are the casing and the tread/belt assembly.

The **casing** cushions the tyre and contains the required volume of air. In fact, the air is the load carrier, not the tyre. Drivers are made aware of this – at the very latest – when they have a flat.

The **tread/belt** assembly envelopes the casing and provides for low rolling resistance, optimum driving behaviour and good mileage.

The **tread/belt** assembly provides a minimal rolling resistance, optimal handling and a long service life. In the early days of tyre development, the casing was made of square woven linen fabric embedded in rubber. However, the crossed threads of the fabric cut away at each other, resulting in a relatively short tyre life.

This prompted Continental to introduce in 1923 a new cord fabric. This featured a unidirectional arrangement of cords held in place by supporting threads and embedded in rubber. Tyres incorporating the new fabric lasted much longer.

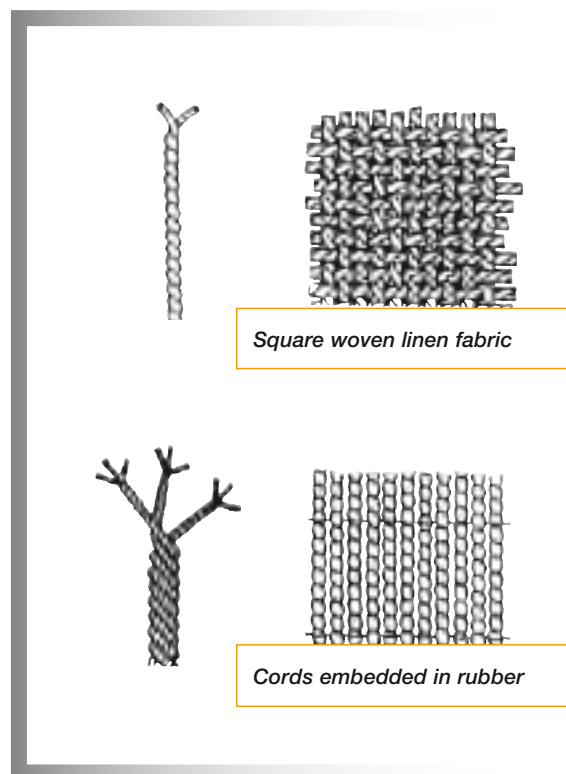

## Steps in the Development of the Pneumatic Tyre

### Cross-ply tyres (until about 1970)

The casing of a cross-ply tyre consists of a number of rubberised cord plies with edges wrapped around the bead wire (the bead ensures that the tyre sits firmly on the rim).

The number of plies determines the load capacity of the tyre. Cross-ply tyres for passenger cars generally had between two and six rayon or nylon cord plies. Even today, van tyres are said to have a **6, 8 or 10 PR** (ply rating = load carrying capacity based on the number of plies).

The individual cord plies of a cross-ply tyre are arranged in a criss-cross pattern at a certain angle – known as the cord angle. This angle determines the tyre's characteristics. An obtuse cord angle, for example, gives better ride comfort but reduces lateral stability. An acute cord angle increases directional stability at the expense of ride comfort.



Cross-ply tyre



Extremely stressful for early cross-ply tyres.

### Modern radial tyres

In modern car engineering, the radial – or belted – tyre has completely replaced the cross-ply tyre.

The cords in a radial tyre casing run perpendicular to the direction of travel. Viewed from the side, the cords run radially - giving the tyre its name.

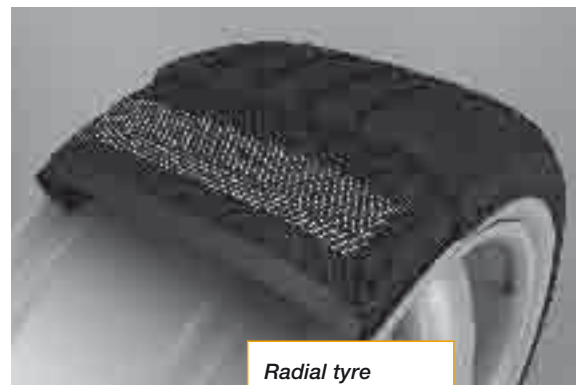

Radial tyre



The weakness of this arrangement is that the cords cannot sufficiently absorb lateral forces when cornering or circumferential forces when accelerating. To compensate this, the cords must be supported or complemented by other structural elements.

The belt assembly comprises several layers of steel belt plies arranged in diagonally opposing directions at a specified angle. The belt assembly provides support and stability to the tread area so that the forces in the 3 principal planes can be transmitted efficiently. Many tyres are additionally stabilised by a nylon cap ply.

Like most tyre manufacturers, Continental produces only modern radial tyres for passenger cars.

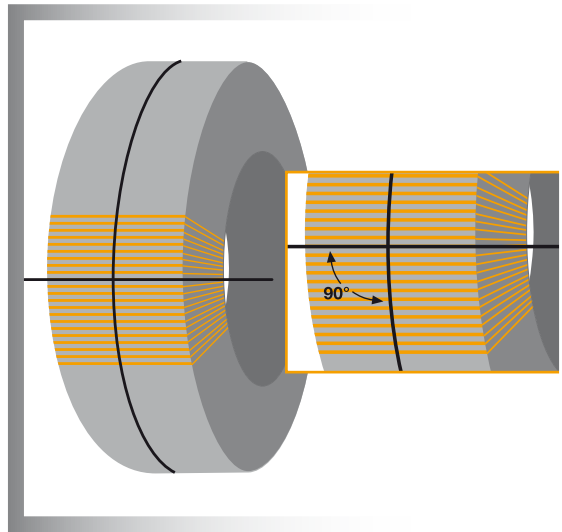

Since time immemorial, higher speed performance has been an aim in automotive developments. From today's vantage point, cross-ply tyres had a very sedate pace at the dawn of the 20th century – exception in racing, of course.



## Materials used in a tyre

The components of a modern radial tyre for passenger cars contain diverse ingredients in differing amounts. These ingredients vary by tyre size and tyre type (summer or winter tyre).

The example below shows the ingredients used in the summer tyre

**205/55 R 16 91V  
ContiPremiumContact 5**

(The tyre shown here weighs about 8.5 kg without the rim).



*Tyre example: ContiPremiumContact 5, 205/55 R 16 91V.*

*Breakdown of ingredients*

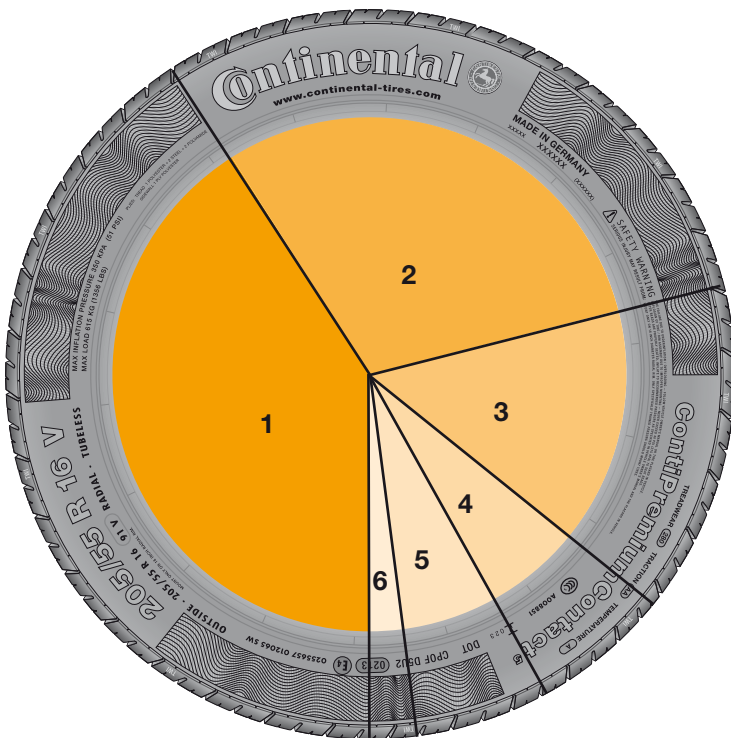

- 1** Rubber  
(natural and synthetic rubber) . . . . .41%
- 2** Fillers  
(carbon black, silica, carbon, chalk ...) . . . . .30%
- 3** Reinforcing materials  
(steel, polyester, rayon, nylon) . . . . .15%
- 4** Plasticizers (oils and resins)<sup>1</sup> . . . . .6%
- 5** Chemicals for vulcanisation  
(sulphur, zinc oxide, various other chemicals) . . . . .6%
- 6** Anti-ageing agents and other chemicals . . . . .2%

<sup>1</sup> As of 2010 stringent mandatory limits are in effect in the EU explicitly for plasticizers classed as harmful to health. Thanks to the use of alternative types of oil, Continental tyres remain well below these limits.

# Tyre Components

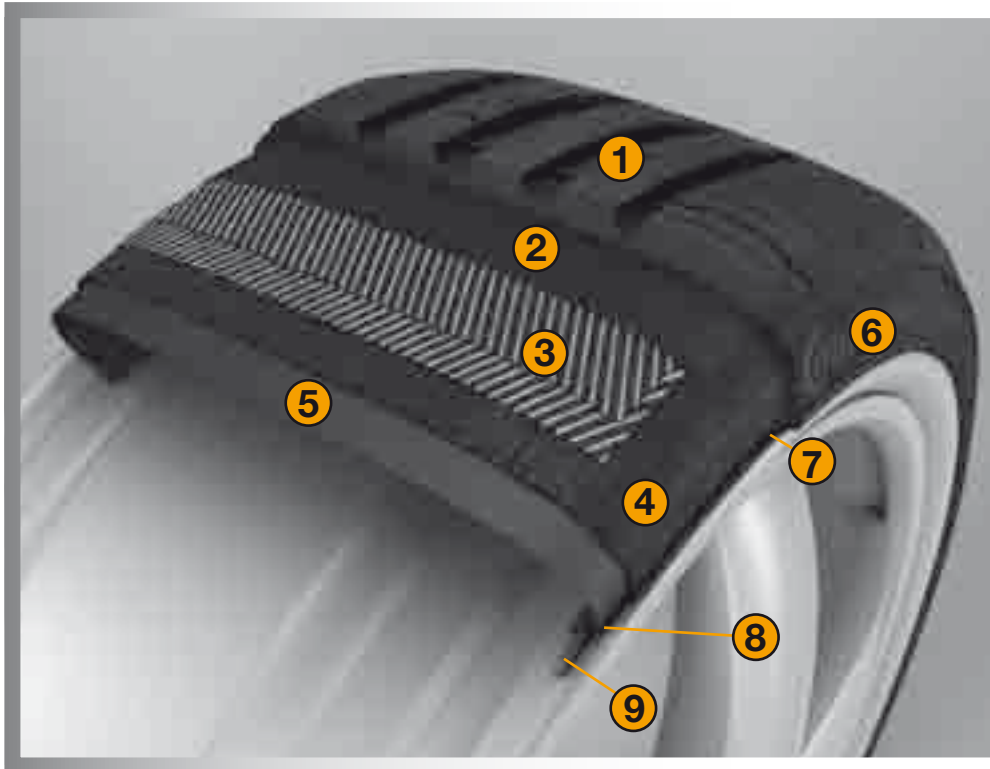

*Every modern passenger car tyre has a complex structure*

A modern tyre is made up of:

- Tread/belt assembly** consisting of
- ① **Tread** – ensures high mileage, good road grip and water expulsion
  - ② **Jointless cap plies** – enable high speeds
  - ③ **Steel-cord belt plies** – optimise directional stability and rolling resistance
- Casing**, consisting of
- ④ **Textile cord ply** – controls internal pressure and maintains the tyre's shape
  - ⑤ **Inner liner** – makes the tyre airtight
  - ⑥ **Side wall** – protects from external damage
  - ⑦ **Bead reinforcement** – promotes directional stability and precise steering response
  - ⑧ **Bead apex** – promotes directional stability, steering performance and comfort level
  - ⑨ **Bead core** – ensures firm seating on the rim

The functions of the individual components are explained on the next two pages. ▶▶

## Components and their functions

### Tread/Belt Assembly

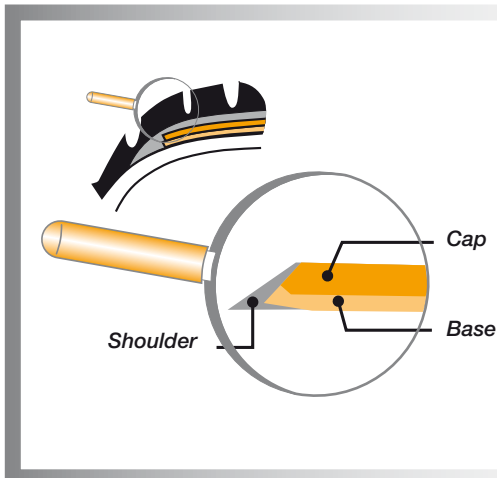

#### 1 Tread

**Material** Synthetic and natural rubber

**Functions**

- ▶ **Cap:** provides grip on all road surfaces, wear-resistance and directional stability
- ▶ **Base:** reduces rolling resistance and damage to the casing
- ▶ **Shoulder:** forms an optimal transition from the tread to the sidewall

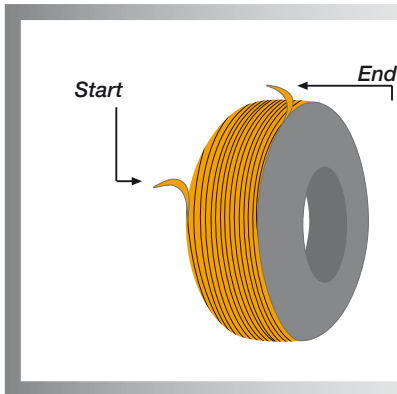

#### 2 Jointless cap plies

**Material** Nylon, embedded in rubber

**Function**

- ▶ Enhances high-speed suitability

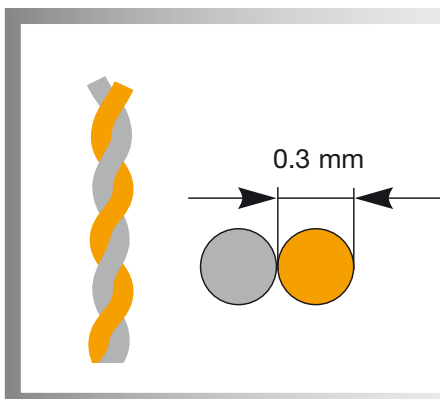

#### 3 Steel-cord for belt plies

**Material** High-strength steel cords

**Functions**

- ▶ Enhances shape retention and directional stability
- ▶ Reduces the rolling resistance
- ▶ Increases the tyre's mileage performance

### Carcass

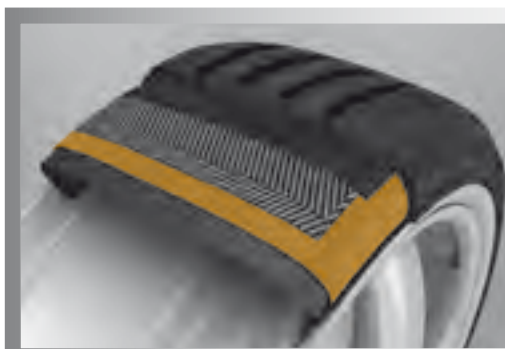

#### 4 Textile cord ply

**Material** Rayon or polyester (rubberised)

**Function**

- ▶ Controls internal pressure and maintains the tyre's shape



## 5 Inner liner

**Material** Butyl rubber

**Functions**

- ▶ Seals the air-filled inner chamber
- ▶ Acts as a tube in tubeless tyres

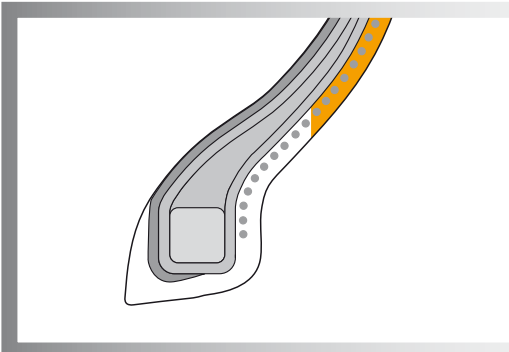

## 6 Side wall

**Material** Natural rubber

**Function**

- ▶ Protects the casing from external damage and atmospheric conditions

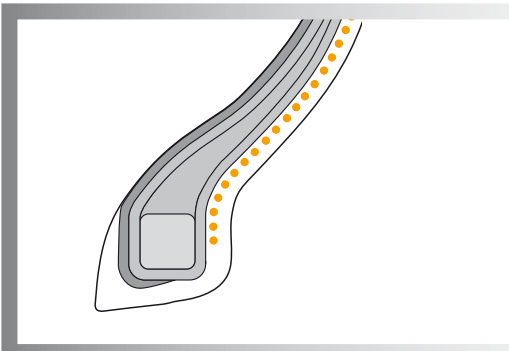

## 7 Bead reinforcement

**Material** Nylon, aramid

**Functions**

- ▶ Enhances directional stability
- ▶ Gives steering precision

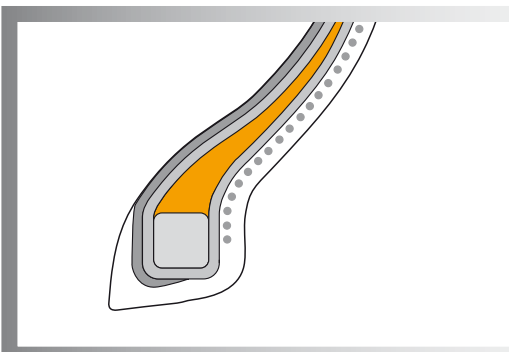

## 8 Bead apex

**Material** Synthetic rubber

**Functions**

- ▶ Enhances directional stability
- ▶ Gives steering precision
- ▶ Improves comfort

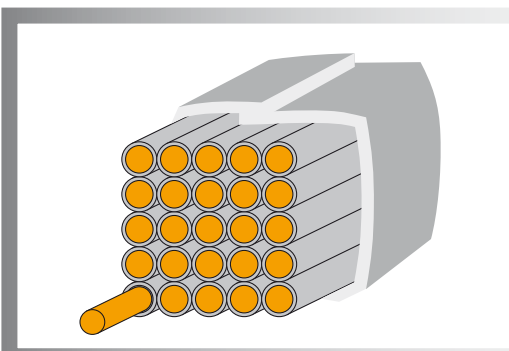

## 9 Bead core

**Material** Steel wire embedded in rubber

**Function**

- ▶ Ensures that the tyre sits firmly on the rim

# Tyre production - a glance around the factory

Supplier industry

Compound production

Manufacture of semi-finished products

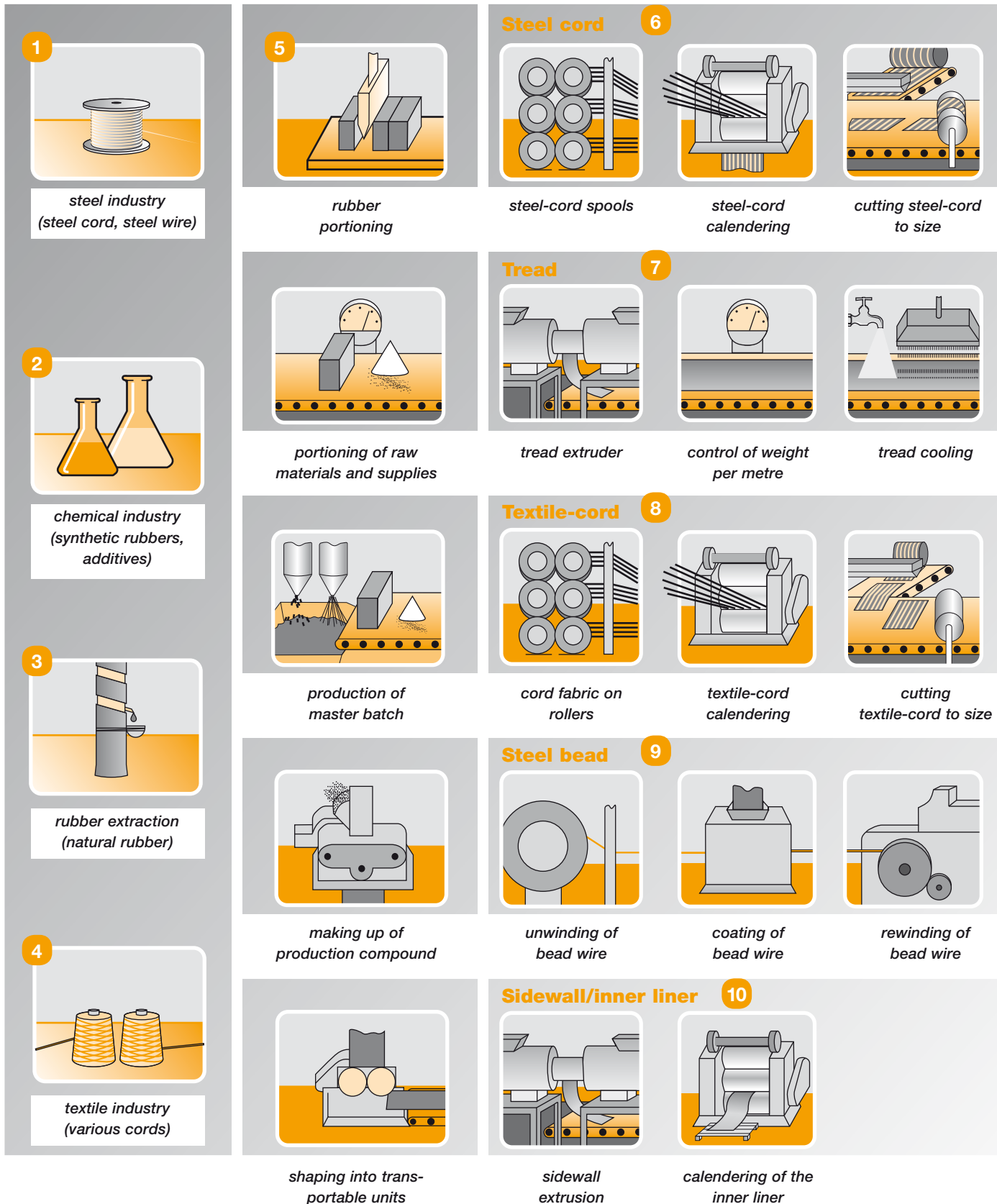

**Building**  
Putting together  
the individual  
components of a tyre

**Vulcanisation**

**Quality  
control**

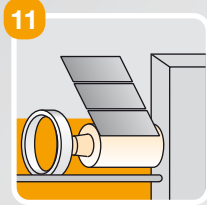

*building of the casing*



*pre-treatment of the "green" tyre*



*final visual inspection*

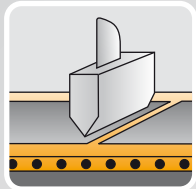

*cutting the tread to size*

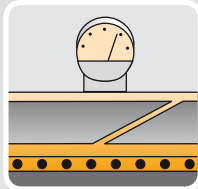

*control of unit weight*

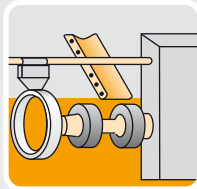

*building of the tread/belt assembly*

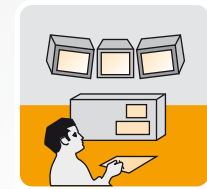

*X-ray control*

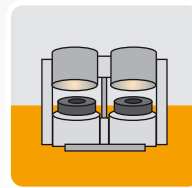

*vulcanisation*

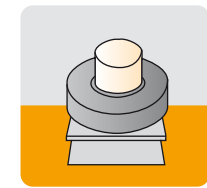

*check for imbalance*

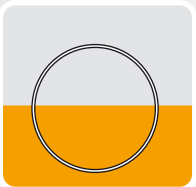

*bead ring*



*applying the apex*

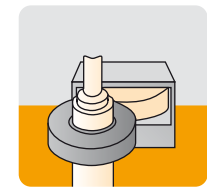

*force variation control*



*Each individual stage of production – from the inspection of the raw materials through to delivery of the finished tyre – is subject to ongoing quality control.*

The chart on double page 14/15 shows the typical stages of production in a modern tyre factory





## Supplier industry and compound production

Various branches of industry supply the tyre industry with raw materials which are pre-treated and further processed into individual semi-finished products:

- 1** The **steel industry** supplies high-strength steel. This serves as the starting material for the manufacture of steel belts (steel cord) and of bead cores (steel wire).
- 2** The **chemical industry** supplies a multitude of raw materials and supplies. The main ones are synthetic rubber and materials used, for instance, to reduce wear, increase grip and lengthen the life of the tyre.
- 3** **Natural rubber** is extracted by cutting into the bark of special trees grown in large plantations. The milky fluid (latex) that flows out coagulates when acid is added to it. It is then cleaned with water and pressed into solid bales for easier transportation and storage.
- 4** The **textile industry** supplies base materials (rayon, nylon, polyester and aramid fibres) for the manufacture of cord which serve as a reinforcing material in tyres.
- 5** Bales of natural and synthetic rubber are sectioned, cut into portions, weighed and mixed with other ingredients in accordance with specially defined recipes.  
Up to twelve different rubber compounds are used today in the various integral components of modern passenger car tyres.<sup>1</sup>

## Manufacture of semi-finished products

- 6** **Steel cord**  
Pre-treated steel cord is supplied on wire spools and fed into a calender via special spoolers. In the calender, the steel cord is embedded in one or more layers of rubber. This continuous sheet of cord and rubber is then cut at a defined angle to the right length for the tyre size and rolled up for further processing.
- 7** **Tread**  
The kneadable material previously blended in the mixer is shaped into an endless strip by means of a screw-type extruder.

After extrusion, the weight per metre is checked and the tread cooled by immersion. The tread strip is cut to length for the tyre size and a unit weight control is carried out.

- 8** **Textile cord**  
A multitude of textile threads are fed into the calender by large rollers device. There they are embedded in a thin layer of rubber. This endless sheet is then cut to the desired width at a 90° angle relative to the direction of travel and rewound for further processing.
- 9** **Steel bead**  
The core of the bead is made up of many annular steel wires each of which has its own rubber coating. This hoop is then provided with a rubber apex.
- 10** **Sidewall/inner liner**  
Sidewall sections cut to suit the particular tyre size and exhibiting various geometries are turned out with the extruder. A calender forms the airtight inner liner into a wide, thin layer.

## Building and vulcanisation

- 11** The various semi-finished products discussed in the previous stages come together on the tyre building machine and are assembled (built) into what is known as a “green tyre” in two stages (casing and tread/belt assembly).
- 12** Prior to **vulcanisation** the “green tyre” is sprayed with a special fluid. In the curing press it then receives its final shape after being vulcanised for a certain time at a certain pressure and temperature. During the process, the plastic raw rubber undergoes a change in its physical properties to become elastic rubber. Also, the press moulds are engraved to give the tyre its tread pattern and sidewall markings.

## Final quality control and shipment

After vulcanisation the tyres undergo visual inspection and X-raying, as well as various tyre uniformity checks.

Once the tyres have passed all the checks and inspections they are sent to the distribution warehouse for shipment.

<sup>1</sup> *Individual tyre components and their functions are described in detail on pages 12 and 13.*

## The outside of a tyre

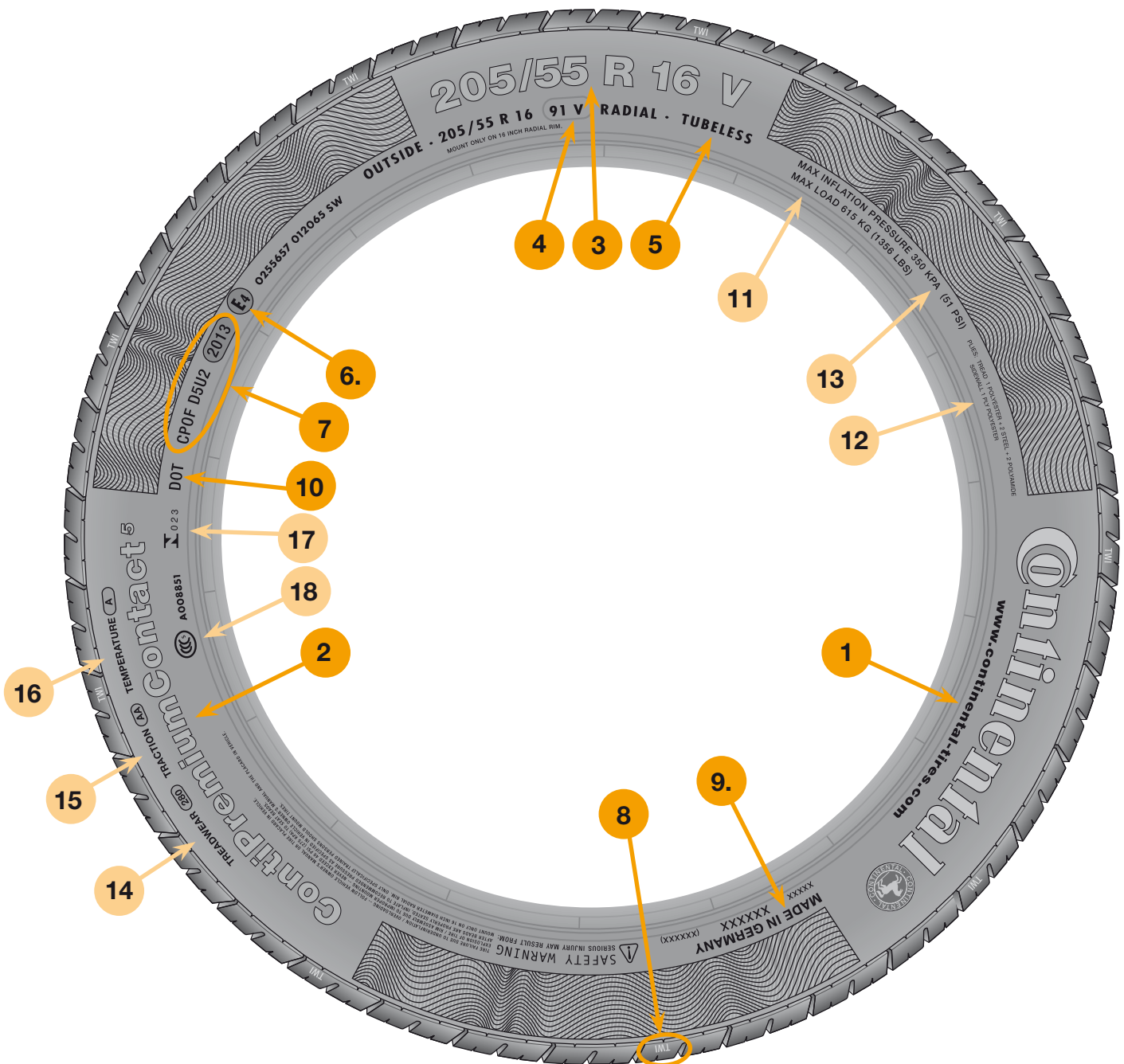

## Abbreviations



DOT = U.S. Department of Transportation

ETRTO = European Tyre and Rim Technical Organisation, Brussels

ECE = Economic Commission for Europe (UN institution in Geneva)

FMVSS = Federal Motor Vehicle Safety Standards (U.S. safety code)

# Sidewall markings – standard and required by law

- 1 Manufacturer (trademark or logo)
- 2 Product name
- 3 Size designation
  - 205 = Tyre width in mm
  - 55 = Height-to-width ratio in percent
  - R = Radial construction
  - 16 = Rim diameter in inches (code)
- 4 91 = Load index  
(see also page 22)
  - V = Speed index  
(see also page 22)
- 5 Tubeless radial tyre
- 6 Continental tyres are marked in accordance with international regulations. So the sidewall is marked with a circle containing an E and the number of the country of homologation. This marking is followed by a multi-digit homologation number, e. g.   (4 = Netherlands)
- 7 Manufacturer's code:
  - ▶ Tyre factory, tyre size and type
  - ▶ Date of manufacture (week/year)  
2013 means the **20th** week of **2013**
- 8 **T.W.I.:** Tread Wear Indicator. A number of small raised bars run across the main grooves. The bars have a height of 1.6 mm and gradually become level with the rest of the tread as the tyre wears (see also page 21)
- 9 Country of manufacture

## All other information applies to countries outside Europe:

- 10 **Department of Transportation** (U.S.A. department which oversees tyre safety standards)
- 11 U.S. load rating for max. load (615 kg per wheel = 1356 lbs.) where 1 lb. = 0.4536 kg
- 12 **Tread:** beneath which there are 4 plies
  - ▶ 1 polyester ply,  
2 steel belt plies, 1 polyamid ply**Sidewall:** the tyre casing consists of
  - ▶ 1 polyester ply
- 13 U.S. limit for max. inflation pressure 51 psi (1 bar = 14.5 psi)
  - ▶ Information for consumers based on comparison values with standard reference tyres (standardised test procedures)
- 14 **Treadwear:** relative life expectancy of the tyre based on standard U.S. testing (as % of the value for the reference tyre)
- 15 **Traction:** A, B or C = wet braking capability of the tyre
- 16 **Temperature:** A, B or C = temperature stability of the tyre at higher test speeds. C is sufficient to meet U.S. statutory requirements
- 17 **Identification for Brasil**
- 18 **Identification for China**

## Tread Pattern

The first pneumatic tyres had a smooth-tread with no pattern. As automobiles became faster, however, there were increased problems with handling characteristics and road safety. Therefore, as early as 1904, Continental developed the first automobile tyre with a tread pattern.

Since then, tread patterns have been continuously developed and optimised to incorporate, for example, ingenious tread block geometry and fine siping techniques.

Today, smooth-tread tyres or “slicks” are only found in motor racing. Tyres used on public roads must have a tread pattern by law. The main job of the tread pattern is to expel water which can affect the tyre’s contact with the road in wet conditions. In addition the tread

pattern, especially that of winter tyres, provides grip and adhesion.

On wet roads at high speeds, a wedge of water can build up between the tyre and the road surface. The **tyre may then start to lose road contact or aquaplane**, and the vehicle can no longer be steered.

Sufficient tread depth is vital not only in such extreme situations. Even at low speeds, there is a greater risk of having an accident in wet weather if the tyres are worn.

The table below shows just how important the amount of remaining tread is. The **braking distance for a worn tyre with a tread depth of 1.6 mm<sup>1</sup> is almost twice** as long as for a new tyre with about 8 mm tread depth.

## Braking distance in relation to tread depth

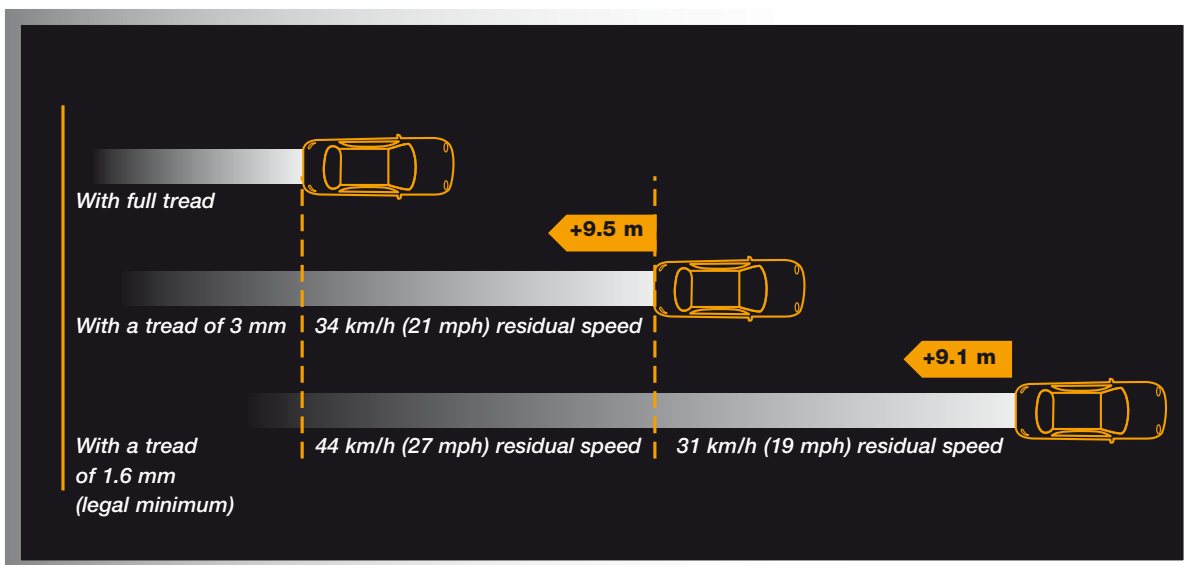

Braking in the wet from 80 km/h (50 mph) to a full stop. The braking difference shown was calculated using a Mercedes C-class vehicle with 205/55 R 16 V tyres in over 1,000 braking

tests. The graphics shown are for illustration only. The braking distance for each individual vehicle depends on the type of vehicle, brakes and tyres, and also the road surface.

Tyres have tread across their entire circumference. Tread depth measurements must be taken in the main grooves which feature TWIs<sup>2</sup> on modern tyres.

In most European countries the law specifies a minimum tread depth of 1.6 mm; that's when tyres have to be replaced.

In order to ensure the tyres always offer best possible performance, **summer tyres** should be replaced when they reach a depth of **3 mm**, and **winter tyres** when they reach a depth of **4 mm**. Also, all four wheel positions should be fitted with tyres of the same tread pattern design<sup>3</sup>, and each axle, at least, should have tyres with the same tread depth.

Regrooving of passenger car tyres is forbidden by law.



<sup>1</sup> Tread depth required by law

<sup>2</sup> TWI = Tread Wear Indicator, small raised bars across the main grooves. The bars have a height of 1.6 mm and gradually become level with the tread as the tyre surface wears. Continental winter tyres also have tread wear indicators with height of 4 mm. They indicate the tread depth at which the tyre begins to lose its winter properties.

<sup>3</sup> Recommendation:  
One should avoid mixing summer and winter tyres in particular, which is even illegal in some European countries. See section on "Winter tyres".

## Tyre Selection

Tyre sizes which have been approved for a vehicle are specified in the vehicle's documents.

Each tyre must be suitable for the vehicle. This applies to its outer dimensions (diameter/rolling circumference, width) which are indicated in the tyre's standardised size designation (see page 19).

Also, the tyre must comply with the vehicle's requirements in terms of load and speed:

As far as load is concerned, tyre selection is based on the maximum permissible axle load which is distributed among two tyres. The maximum load capacity of a passenger car tyre is indicated by its **load index (LI)**.

Correct choice of tyre also includes the **speed rating**: the tyre's maximum speed must be at least equivalent to that of the vehicle, plus tolerance<sup>1</sup>. The maximum permissible speed (at full load) of a tyre is indicated by its **speed index (SI)**.

Together, the LI and SI make up the service description for a passenger car tyre. This description is an official part of the complete, standardised size designation appearing on each tyre and must conform to the information given in the vehicle documents.

The dimensions and technical properties of SSR runflat tyres and self-sealing ContiSeal tyres<sup>2</sup> correspond to those of standard tyres of the same size and construction. SSR tyres may however only be mounted on vehicles with a tyre pressure monitoring system.

<sup>1</sup> Exception: winter tyres, see page 24

<sup>2</sup> For details about these tyre concepts refer to the Technical Databook Car, 4x4, Van

### Load Index (LI)

and maximum load per individual tyre

LI	kg	LI	kg	LI	kg	LI	kg
50	190	69	325	88	560	107	975
51	195	70	335	89	580	108	1000
52	200	71	345	90	600	109	1030
53	206	72	355	91	615	110	1060
54	212	73	365	92	630	111	1090
55	218	74	375	93	650	112	1120
56	224	75	387	94	670	113	1150
57	230	76	400	95	690	114	1180
58	236	77	412	96	710	115	1215
59	243	78	425	97	730	116	1250
60	250	79	437	98	750	117	1285
61	257	80	450	99	775	118	1320
62	265	81	462	100	800	119	1360
63	272	82	475	101	825	120	1400
64	280	83	487	102	850	121	1450
65	290	84	500	103	875	122	1500
66	300	85	515	104	900	123	1550
67	307	86	530	105	925	124	1600
68	315	87	545	106	950		

### Speed Index (SI)

SI	Maximum speed for passenger car tyres
P	150 km/h / 93 mph
Q	160 km/h / 99 mph
R	170 km/h / 106 mph
S	180 km/h / 112 mph
T	190 km/h / 118 mph
H	210 km/h / 130 mph
V	240 km/h / 150 mph
W	270 km/h / 169 mph
Y	300 km/h / 187 mph
ZR	exceeding 240 km/h / 150 mph

# Tyre Inflation Pressure

Modern tubeless tyres have very little in common with their predecessors dating from the start of last century – apart from the basic principle of being pneumatic and containing compressed air. It is the pressure inside that gives the tyre its stability and load-carrying ability combined with the necessary elasticity.

Correct tyre pressure is vital for correct vehicle operation in different service conditions (loads, speeds). The optimal tyre pressure is defined in close consultation between the tyre and vehicle manufacturers. It is stated in the **user manual and/or indicated on the vehicle itself** (on the inside of the fuel tank flap, for instance). (See also the **Continental inflation pressure tables**)

*As tyre inflation pressure **decreases**, so **does the life expectancy of the tyre.***

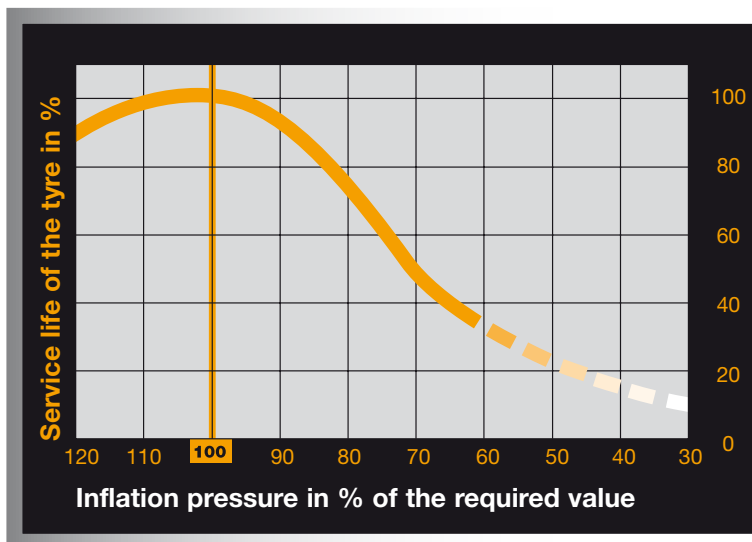

Tyre inflation pressure must be adjusted to suit various loads and operating conditions.

It should always be checked **when the tyres are cold**. As inflation pressure always increases when the tyres are warm, air must never be released. Insufficient inflation pressure puts stress on the tyre and leads to excessive heat build-up in the flexing zone which then results in tyre damage. The inflation pressure must always be the same for all tyres on any one axle, but it can vary from axle to axle (on the front and rear axles, for example).

**Fuel consumption goes up as the tyre pressure goes down.**

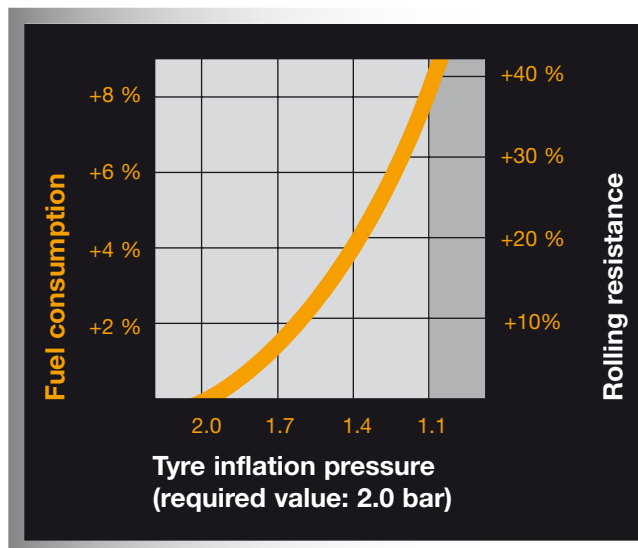

The pressure should be checked regularly about **every 2 weeks**, or before taking a long journey (driving at high speed, with heavy luggage). An inflation level inappropriate to the amount of stress the tyre must withstand can have a considerable negative effect on the vehicle's handling.

The **spare tyre** should also be checked in order to ensure that it is available at all times.

Add an extra 0.2 bar to the inflation pressure of **winter tyres**. This compensates for the lower outside temperatures during the winter months.

**Valve caps** must be screwed firmly into place as they protect the valve from dust and dirt. Missing valve caps must be replaced immediately.

Major losses of air between tyre pressure checks indicate damage. A qualified tyre fitter should be asked to investigate and eliminate the problem.

## Winter Tyres

Tyres marked M+S are designed for winter Mud and Snow – (ETRTO<sup>1</sup> definition). This does not specify any defined winter performance.

Because most all-year tyres offer insufficient winter performance, a series of test conditions and minimum requirements have been specified in the USA and are indicated by the “Snowflake on the Mountain” symbol.

### Snowflake on the Mountain



A tyre marked with the snowflake must offer a minimum 7% improvement in braking performance on snow vis-à-vis a uniformly defined standard reference tyre.

All winter tyres from Continental made for the European market satisfy the requirements of the “Snowflake” symbol and offer optimum safety in wintry conditions.

Continental developed the first prototypes of a special winter tyre for use on snow and ice as early as 1914. Continental's first series-made winter tyres were launched in 1952.

Early winter tyres had massive bars, they were loud, hard and, by today's standards, only moderately suitable for winter use. Also, they could only be driven at relatively low speeds.

The real market breakthrough for winter tyres came with the development of special tread compounds for winter service and modern sipe technology (fine slots in the tread).

Ice, snow and low temperatures need not put motorists at greater risks on the road.

<sup>1</sup> ETRTO - European Tire and Rim Technical Organisation

<sup>2</sup> M+S stands for mud and snow

By switching to winter tyres, one can still maintain a high margin of safety. When temperatures drop, winter tyres perform better than ultra high-performance (UHP) summer tyres.

The highly developed, specialized tread compounds used in such tyres are designed to provide the highest possible levels of grip at ambient temperatures above +7°C.

Such tread compounds are however very sensitive to temperature.

Permanent damage may occur to the tread compounds of such tyres if they are used at temperatures below - 20°C.

At this temperature, the tread compounds of UHP summer tyres may lose their elasticity and become brittle (the so-called brittleness point). When this occurs and the tyre is flexed, the tread compound may crack.

Therefore, UHP summer tyres should not be used at temperatures below - 20°C.

Continental tyres with an M+S marking on the sidewall are suitable for use down to - 45°C.

When it gets cold outside, winter tyres give superior performance on wet and slippery roads. Winter tyres should be fitted when the temperature drops below 7°C.

It is not recommended to mix summer and winter tyres on passenger cars. In most European countries, motorists are required to fit only summer tyres or only winter (M+S<sup>2</sup>) tyres to any one axle; in some countries<sup>3</sup> this also applies to all four tyre positions.

Winter tyres must satisfy certain requirements, such that the minimum legal tread depth of 1.6 mm is no longer sufficient. Winter tyres with a tread depth of 4 mm are at the limit of their winter capabilities. Continental recommends that winter tyres are replaced at latest when a tyre tread depth of only 4 mm remains, or are used only in the summer season.

<sup>3</sup> Exception: Winter tyres with less than 4 mm tread depth for passenger cars which no longer count as winter tyres in Austria.



## Winter indicator



Continental recommends a minimum tread depth of 4 mm for using winter tyres on wintry roads and identifies this by means of a special winter tyre wear indicator that the tyre is equipped with **in addition to** the 1.6 mm TWI.<sup>1</sup>

When the tread has worn down to a residual depth of 4 mm – regarded as the limit for winter suitability – the winter tyre wear indicator appears flush with the tread pattern surface.

Top safety in winter can be provided only by true winter tyres on all axle positions (4 tyres).

It is vital that winter tyres are always kept inflated at the correct pressure since the volume of air contained in the tyre decreases at very low temperatures. (see also page 23)

Depending on the type and designation, the **maximum speed for winter tyres** is 160 km/h (100 mph – speed index Q), 190 km/h (118 mph – speed index T), 210 km/h (130 mph – speed index H), 240 km/h (150 mph – speed index V) or, even

270 km/h (168 mph – speed index W). Vehicles designed for higher speeds than the respective winter tyres must exhibit a sticker – clearly within the driver's range of view – citing the maximum permissible speed for the M+S tyres<sup>2</sup>.

<sup>1</sup> 1.6 mm = Tread depth required by law

<sup>2</sup> Not applicable in the UK

## Why winter tyres?

### Performance features

### winter tyres

### summer tyres

Performance features	winter tyres	summer tyres
Dry Roads		+
Wet Roads		+
Snow	+	
Ice	+	
Comfort	+	+
Rolling Noise	+	+
Rolling Resistance	+	+
Mileage	+	+

One of the most crucial properties of a tyre is its grip on the road, particularly in winter. The following three components are the most critical for winter tyres. It is the interaction of all three components which offers the best possible characteristics for meeting the many different surface conditions possible in winter.

## Tyre compound

Summer rubber compounds begin to harden below 7 °C and no longer provide the levels of grip required. The special technology offered by winter tyres means they remain flexible and offer sufficient grip even at low temperatures.

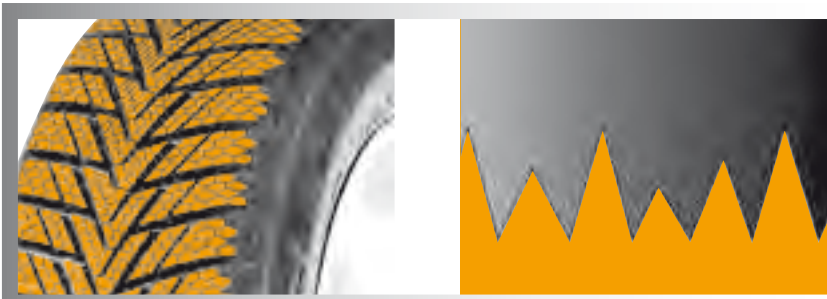

**More grip thanks to more effective tyre compounds**

## Tread pattern

The tread pattern used on a winter tyre is particularly effective on snow and slush. In these conditions, the rotation of the wheel presses the snow into the wider grooves used on this type of tyre, thereby generating additional traction.



**Better traction thanks to deeper contact with snow**

## Sipes

When setting off, rows of fine lateral sipes enable the tread blocks to flex and bite deeper into the ice or snow for better traction.

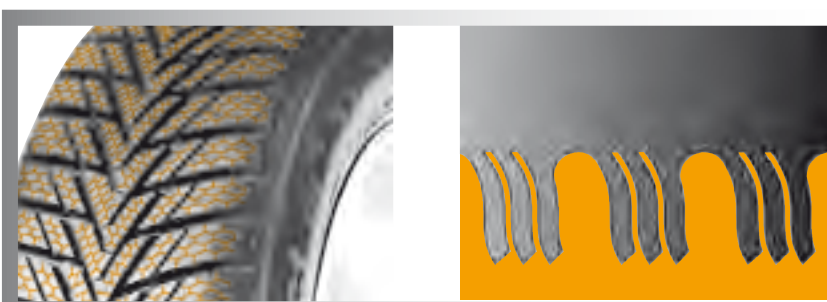

**Enhanced traction thanks to additional bite**

## Tyre Storage<sup>1</sup>

New tyres which are properly stored and handled lose virtually none of their properties and characteristics even over a period of several years.

When removing the tyre, one should make a note of the wheel position (by chalk marking the tyre "FL" for front left, for example). Certainly when it is time to change from summer to winter tyres, one should use the opportunity to switch the wheels round (from front to back, and vice versa). This results in better economy, particularly in the case of vehicles with front-wheel drive.

When changing the wheel position, always observe the recommendations in the car manual.

<sup>1</sup> For further details about tyre storage see *Technical Databook Car, 4x4, Van*

### Tyres with rims (1 bar)

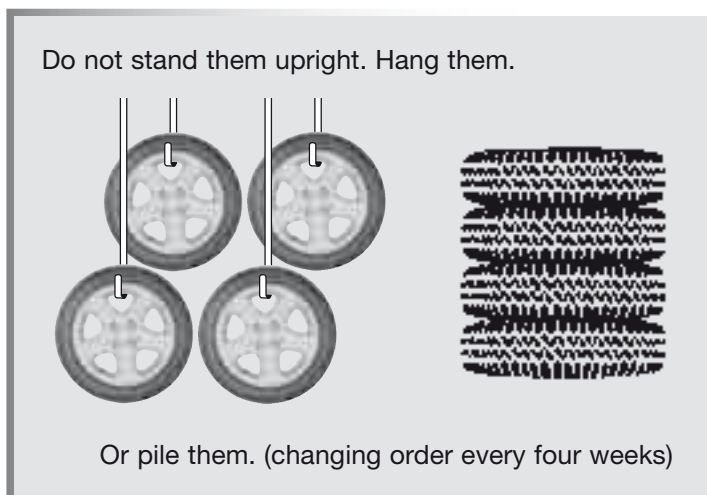

### Tyres without rims

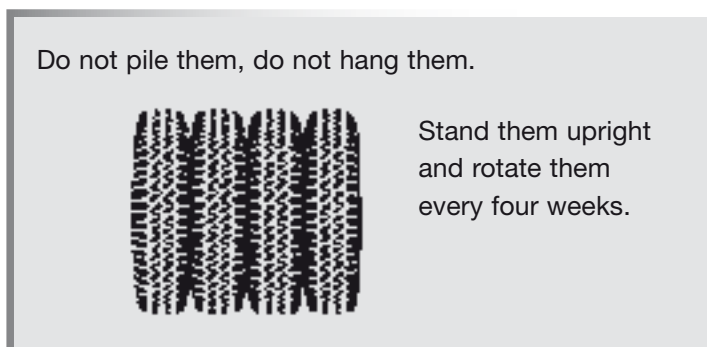

### Storage place

#### Cool

15°C to 25°C

Shield tyres from sources of heat

Minimum distance of 1 m from any heat source

#### Dry

Avoid condensation

Tyres must not come in contact with oil, grease, paint or fuel

#### Dark

Protect tyres from direct exposure to sunlight and artificial lighting with a high UV content

#### Moderately ventilated

Oxygen and ozone are particularly harmful

## Wheels and Rims

What's the “difference” between a wheel and a rim?

When man began moving heavy loads by rolling them, he started by using logs of trees. Later on, wooden slabs were cut from tree trunks and cut into round discs. These discs had a hole in the centre to accommodate either a rigid or rotating axle. After many intermediate stages, the wheel was given a hub which, in a spoked wheel, was connected with the wheel rim by spokes. In order to protect the wheel from wear it usually had a leather or iron band. It then stayed this way for several centuries.

At the end of the nineteenth century, the motor car came along, and with it the pneumatic tyre, bringing a whole new era.

To attach the tyre to the wheel, a steel rim was needed. The first pneumatic tyres were firmly vulcanised on to the rim; later they were fixed to the rim by means of complicated mechanisms, but they were removable. There was further development before reaching today's conventional method of joining the tyre and rim.

To ensure that the tyre sat firmly on the rim, the latter was equipped with outwardly arching flanges against which the tyre was pressed by compressed air. The basic structure has remained the same since then, although the rim's cross-sectional shape has changed in the course of further development.

The rim is, therefore, not a wheel but rather part of a wheel. Spokes or a metal nave connect the rim to the vehicle.

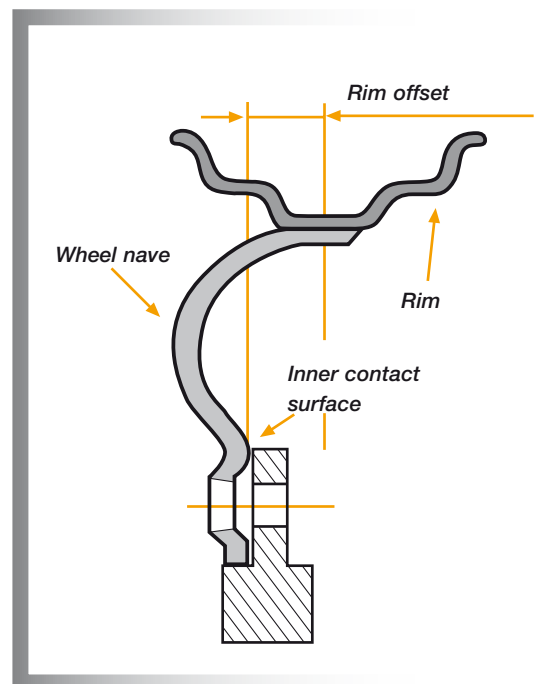

## Rim + wheel nave = disc wheel

For modern vehicle construction, the rim offset is crucial. For this reason it may be altered only slightly, even if changes are made in the axle geometry.

The rim offset (mm) is the distance measured from the centre of the rim of a disc wheel to the inside contact face of the wheel disc, where it presses against the hub flange. This value can be either positive or negative.

The following points must be observed when fitting tyres to rims: tyre and rim must correspond in terms of diameter, and must be approved in that combination for the vehicle

type. It is essential that the rims used are dimensionally accurate, clean and rust-free, and neither damaged.

### There are several rim contours:

- ▶ 1. Drop centre rim (normal)
- ▶ 2. Hump rim = safety contour
- ▶ 3. Ledge rim = safety contour

Thanks to slight curvatures, rims 2. and 3. guarantee the tubeless tyre sits firmly on the rim. Such rims are absolutely essential for tubeless radial tyres.

Passenger car hump rim

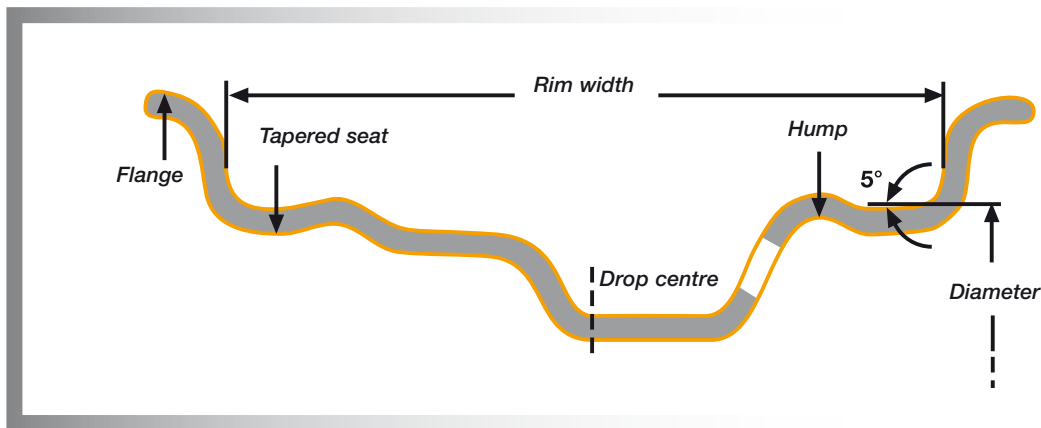

### Example: 6 1/2 J x 16 H2 B ET 45 (to DIN 7817)

<b>6 1/2</b>	Rim width (in inches)
<b>J</b>	Flange type
<b>X</b>	Drop centre
<b>16</b>	Diameter (in inches)
<b>H2</b>	Double hump
<b>B</b>	Asymmetrical drop centre
<b>ET45</b>	Rim offset in mm

The hump rim is a safety rim of the kind used on bicycles, motorcycles, passenger cars, agricultural and other commercial vehicles. The drop centre is necessary in fitting the tyre on the rim.

## The EU Tyre Label

In order to provide standardised information on fuel efficiency, wet grip and external rolling noise, the European Union is to introduce a **compulsory label for all new tyres. By November 2012** all relevant new tyres sold in Europe must carry this EU label.

The label is intended to give end-users some essential information to help them when choosing new tyres.

### The Tyre Label will generally apply to:

- ▶ Car and SUV tyres
- ▶ Van tyres
- ▶ Truck tyres

### It will NOT apply to:

- ▶ Non road-legal tyres, for example racing tyres
- ▶ Re-treaded tyres
- ▶ Spare tyres
- ▶ Vintage car tyres

### Reporting requirements of tyre manufacturers

- ▶ Provision of the EU Tyre Label in the form of a sticker on or with the tyre
- ▶ Provision of the Tyre Label values within specific product communication materials

### Reporting requirements of tyre dealers

- ▶ Provision of the Tyre Label values on or with the invoice
- ▶ The Tyre Label has to be clearly visible within the point of sale or actively shown to the consumer

Continental welcomes the introduction of the new European Tyre Label and the improvement in tyre information for consumers at the point of sale.

Also **tyre tests** conducted by car magazines will continue to be an important source of information for end-consumers since they test up to 11 **further safety relevant product properties** in addition to the 3 criteria shown on the label.

For winter tyres, other performance criteria become important which are not included on the label.

## Design Tyre-Label

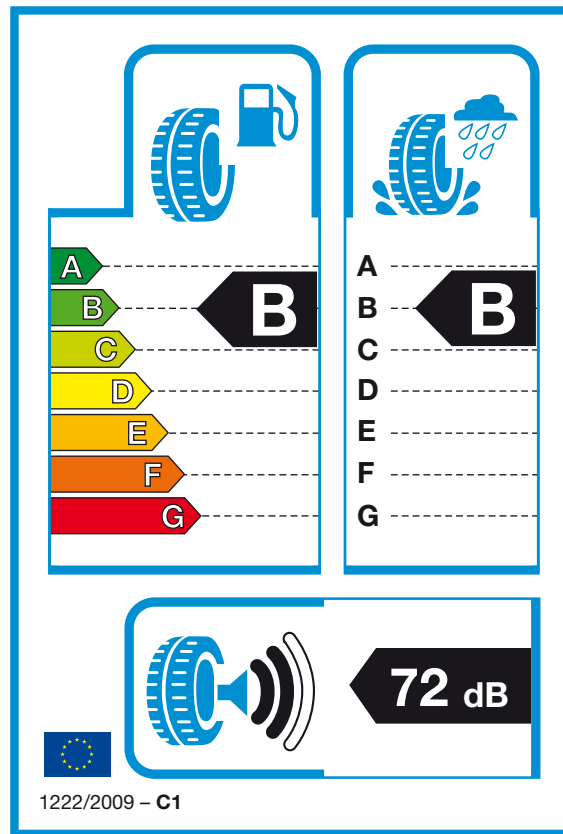

### Fuel efficiency

Fuel efficiency is important to reduce both CO<sub>2</sub> emissions and the cost of driving. The difference between each category means a reduction or increase in fuel consumption of between 0.42 and 0.56 mpg for a 36 mpg car.



### Safety

**Wet grip** is a critical safety feature and relates to the tyres ability to stop a vehicle quickly on wet roads and can be expressed in terms of stopping distance.

The difference in each category shown means a stopping distance of between one and two car lengths (between 3 and 6 metres) when braking from 50 mph.

The difference between categories A and F is more than 18 metres stopping distance.



### Noise

This is the external noise made by the tyre and is measured in decibels. The more black bars shown on the label, the louder the tyres.

[www.continental-tires.com](http://www.continental-tires.com)

0130 1620 Copyright © 2013 Continental Reifen Deutschland GmbH. All rights reserved.

